

Subsea Weld Fittings



GB Series

- Excellent corrosion resistance in subsea environments
 - 316L, Alloy 625, and Alloy 2507 fittings are NACE MR0175/ISO 15156 compliant
 - Alloy 2507 fittings are compliant to NORSOK M-650 and NORSOK M-630/IOGP S-563
- Weld tangent lengths from 3/4 to 2 in.
- Available in sizes from 1/4 to 1 in.

Swagelok® Subsea Weld Fittings

Since 1947, Swagelok has designed, developed, and manufactured high-quality fluid system products to meet the evolving needs of global industries. Our focus is on understanding our customers' needs, finding timely solutions, and adding value with our products and services.

In this catalog you will find technical and ordering information for weld fittings suitable for use in subsea applications. These products have the following pressure characteristics:

Applications

Subsea applications are complex configurations of valves, fittings and other components. The design and materials of the components are determined by operating conditions and the physical environment of each specific well, including key factors such as pressure, flow, temperature and water depth. Swagelok has developed an extensive range of fittings specifically designed for the rigors of subsea applications. Our unique and well-established supply chain ensures full material traceability.

Swagelok is able to supply a range of materials to suit a variety of project requirements, covering pressure ranges up to 22 100 psig (1 522 bar).

Product Type	Maximum Working Pressure, psig (bar)		
	316L	Alloy 2507	Alloy 625
Weld Unions	Up to 11 000 (757)	Up to 21 400 (1474)	Up to 22 100 (1522)
Weld to Male ST (SAE/MS)	Up to 4 568 (314)		
Weld to Male AN (JIC)	Up to 10 000 (689)		
Weld to Cone and Thread Tube Nipple Adapter	Up to 10 000 (689)	Up to 20 000 (1378)	Up to 15 000 (1033)

Our subsea weld fittings are designed to meet the requirements of demanding applications such as the following:

- Subsea Christmas Tree
- Umbilical Termination Assembly
- Steel Flying Lead
- Hydraulic Distribution Manifold
- Subsea ROV Control Panels
- Subsea Control Modules
- Wellhead Control Panels
- Hydraulic Control Panels

Contents

Features, 4

Materials of Construction, 5

Testing, 5

Options, 5

Cleaning and Packaging, 5

Compliance with Industry Standards, 5

Additional Considerations, 5

Pressure Ratings, 6

Welding Precautions, 9

Ordering Information, 10

Dimensions, 13

Straight Fittings

Reducing Union, 13

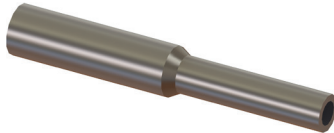

Male Connectors

AN (JIC), 14

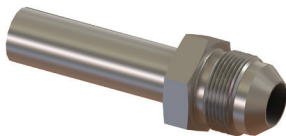

SAE/MS Straight Thread (ST),
Non-Positionable, 15

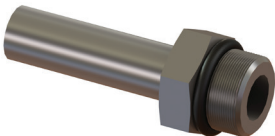

Cone & Thread Tube Nipple
Adapter, 16

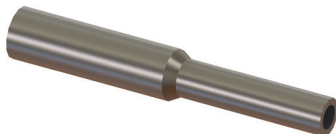

90° Elbows

Union, 17

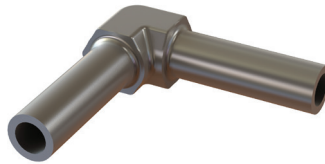

Reducing Union, 18

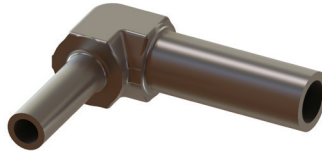

Tees

Union, 19

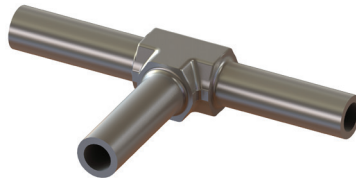

Reducing Union - Branch, 20

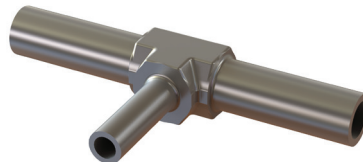

Reducing Union - Run, 21

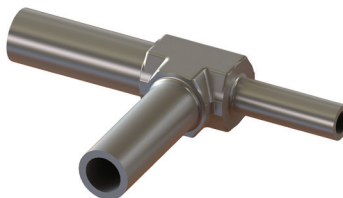

Installation Instructions, 22

O-Seal Male Connectors (ST)

AN (JIC) with Swivel Nut

Medium-Pressure Cone & Thread
Fitting Assembly Using a Cone &
Thread Tube Nipple Adapter

Compatibility of Cone & Thread Tube
Nipple Adapter End Connection (CW)

Related Products, 25

Medium- and High-Pressure Fittings,
Tubing, Valves, and Accessories

Gaugeable Tube Fittings and Adapter
Fittings

Medium- and High-Pressure Fittings
and Adapters—Alloy Materials

Alloy 2507 Tube Fitting

Stainless Steel Tubing

Alloy 2507 Tubing

Tools for Use with Subsea Weld Fittings, 26

Swagelok Welding System

Welding Flux

Tube Facing Tools

Features

Subsea applications have extreme environmental conditions in settings where space is at a premium. Swagelok subsea weld fittings are available in 316L stainless steel, alloy 2507, and alloy 625 to withstand those harsh conditions. Weld tangent lengths of up to 2 inches are standard to facilitate on-site repairs, reducing system downtime and scrap costs.

Additional features of these weld fittings include:

- Two weld geometry options, square and J-groove, that have sharp, burr-free ends which
 - Enhance alignment
 - Maintain tube wall uniformity
 - Promote weld repeatability
- Forgings are pickled and passivated per ASTM A380 prior to machining. All surfaces of the bar stock used for straight fittings are machined.
- 100% Positive Material Identification (PMI) is completed prior to packaging. For more information, see Swagelok *XRF Accuracy and Element Reporting (PMI)*, SCS-00058.
- Alloy 2507 fittings are compliant to NORSOK M-650 and NORSOK M-630/IOGP S-563 and are manufactured from controlled-chemistry material with a minimum pitting resistance equivalent (PRE) value of 42.5, giving it maximum durability in chloride-containing environments.
- 316L stainless steel fittings are manufactured from dual-certified material. Swagelok maintains elevated nickel, chromium, and molybdenum levels for increased corrosion resistance, and sulfur control for a reproducible welding process.
- Alloy 625 fittings are manufactured from dual-melted controlled-chemistry material for optimized corrosion resistance.
- Materials are selected in accordance with NACE MR0175/ISO 15156. For additional information on NACE compliance, see Compliance with Industry Standards, page 5.
- Each fitting is marked to identify the manufacturer, material type, and identification code traceable to the heat melt lot and heat treat lot (if applicable) to ensure raw material traceability.
- All ends are capped prior to shipping for protection.

Optional J-Groove Weld Geometry

J-groove geometry allows for full penetration welds for wall thicknesses larger than or equal to 0.065 in. (1.65 mm). This optional geometry can be ordered as a “GBJ” series fitting.

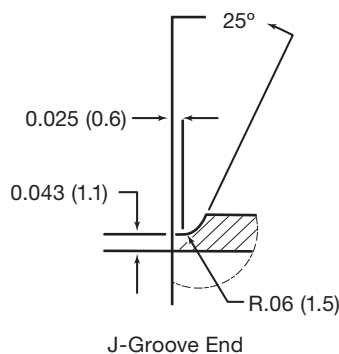

Reduced Stress Concentrations

GB series fittings are designed with a large radius on the transition from the weld diameter to the hex or wrench pad, which reduces the stress concentration in the transition area. Due to this larger radius, the weld tangent length is measured from the face of the part to the beginning of the radii to ensure engagement in the weld fixture. In addition, only low-stress marking methods such as laser marking and hot marking within the forging process are used.

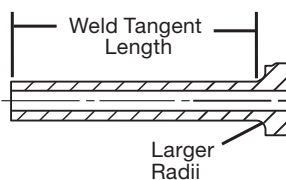

Materials of Construction

Material	Designator	Specifications
Bar Stock^①		
316L stainless steel	316L	ASTM A479/A479M
Alloy 625	625	ASTM B446, Grade 1
Alloy 2507	2507	ASTM A479/A479M
Forgings^②		
316L stainless steel	316L	ASTM A182/A182M
Alloy 2507	2507	ASTM A182/A182M, Grade F53

① Includes straight configurations.

② Includes all elbows and tees.

Testing

Swagelok raw materials undergo extensive testing, including 100% ultrasonic analysis and eddy current testing.

Subsea weld fittings undergo additional raw material testing to ensure they meet demanding subsea application requirements.

- Alloy 2507: barstock and forgings must pass an austenite spacing test according to *Design of Duplex Stainless Steel Subsea equipment Exposed to Cathodic Protection* (DNV-RP-F112). This ensures a fine-grained microstructure for optimal resistance to potential hydrogen embrittlement in cathodically protected installations using sacrificial anodes.
- Alloy 625: barstock is tested for resistance to intergranular corrosion in accordance with ASTM G28. Microstructural characterization assures the presence of a uniformly fine grain size and the absence of excessively large grains for increased corrosion resistance.

Contact your authorized sales and service representative for additional details on the raw material testing and certification completed for subsea weld fittings.

Options

Liquid Penetrant Surface Examination

GB series fittings are available with liquid penetrant surface examination. The accessible surfaces of the finished weld fitting are liquid penetrant inspected in accordance with ASTM E-165, *Standard Practice for Liquid Penetrant Inspection Method*.

To order, add **-FP** to the ordering number.

Controlled Surface Finish

Controlled surface finishes on the weld end are available. Interior surfaces on the weld end can be finished to an average 63 μin (1.60 μm) R_a .

To order, add **-63** to the ordering number.

O-Rings for ST Fittings

ST fittings include a 90 durometer Fluorocarbon FKM O-ring. Other materials are available upon request. O-rings are coated with a thin film of silicon-based lubricant. Removal of factory-applied lubricants may alter performance.

Fittings are available without an O-ring.

To order without an O-ring, add **-XR** to the ordering number.

swagelok.com

Cleaning and Packaging

Weld fitting components are cleaned to remove machine oil, grease, and loose particles. For more information, see *Swagelok Standard Cleaning and Packaging (SC-10)*, [MS-06-62](#).

Compliance with Industry Standards

NACE MR0175/ISO 15156

Swagelok GB series weld fittings meet the requirements of NACE MR0175/ISO 15156 for use in any equipment if the fitting is wetted internally, but not externally, to sour gas environments (i.e. H₂S-containing production fluids).

In compliance with the NACE MR0175/ISO 15156 standard, fitting bodies are marked with “SG” to indicate suitability for sour gas applications.

Material	Table in NACE MR0175/ISO 15156	Raw Material
316L	A.2 (Material type: UNS S31603)	Straight fittings are produced from solution-annealed bar stock. Shaped fittings are produced from solution-annealed forgings.
Alloy 2507	A.24	Straight fittings are produced from solution-annealed bar stock. Shaped fittings are produced from solution-annealed forgings.
Alloy 625	A.13	Straight fittings are produced from bar stock in the annealed condition.

For NACE compliance of GB series fittings which are wetted externally to sour gas environments, contact your authorized sales and service representative.

Additional Considerations

Consult ASME Boiler and Pressure Vessel Code, ASME B31.1, ASME B31.3, or other applicable codes for information on weld setup, technique, and additional considerations for welded systems.

The choice of fitting and tubing material being welded is critical. Using the same materials will ensure the same coefficients of expansion and will reduce the possibility of poor welds, out-of-roundness, or dimensional changes.

Pressure Ratings

Pressure ratings are dependent on the end connection or system component with the lowest pressure rating. Ratings for the end connections used in this catalog are identified below. For additional end connection ratings, refer to the applicable product literature.

Swagelok Subsea Weld Connections – GB Series

Swagelok subsea weld fitting maximum allowable working pressures are based on the **weld fitting dimensions** and allowable stress values as listed below. Calculations are based on maximum outside diameter and minimum wall thickness.

316L Weld Connections^①

Allowable working pressures are calculated from an S value of 20 000 psi (137.8 MPa) for 316 stainless steel in accordance with ASME 31.3. 316L stainless steel material is controlled in accordance with Swagelok material specifications and possesses minimum room temperature tensile and yield strengths equivalent to 316 stainless steel. Working pressures are for temperatures from -20 to 100°F (-28 to 37°C). See **Elevated Temperature Factors** for ratings above 100°F (37°C).

Tube OD in.	Tube Wall Thickness, in.									
	0.035	0.049	0.065	0.083	0.095	0.109	0.120	0.134	0.156	0.188
Working Pressure, psig (bar)										
1/4	5 600 (385)	8 200 (564)	11 000 (757)							
3/8		5 200 (358)	7 100 (489)	9 300 (640)	10 800 (744)					
1/2			5 100 (351)	6 700 (461)	7 800 (537)	9 200 (633)				
5/8				5 200 (358)	6 100 (420)	7 100 (489)	7 900 (544)			
3/4					5 000 (344)	5 800 (399)	6 400 (440)	7 300 (502)	8 700 (599)	
1							4 700 (323)	5 300 (365)	6 300 (434)	7 800 (537)

^① No allowance is made for corrosion, erosion, welding, or elevated temperatures.

Alloy 2507 Weld Connections^①

Allowable working pressures are calculated from an S value of 38 700 psi (286 MPa) for S32750 (grade F53 forging) in accordance with ASME B31.3. Working pressures are for temperatures from -20 to 100°F (-28 to 37°C). See **Elevated Temperature Factors** for ratings above 100°F (37°C).

Tube OD in.	Tube Wall Thickness, in.									
	0.035	0.049	0.065	0.083	0.095	0.109	0.120	0.134	0.156	0.188
Working Pressure, psig (bar)										
1/4	10 800 (744)	15 500 (1067)	21 400 (1474)							
3/8		10 100 (695)	13 700 (943)	17 900 (1233)	20 900 (1440)					
1/2			10 100 (695)	13 000 (895)	15 400 (1061)	17 800 (1226)				
5/8				10 100 (695)	12 100 (833)	13 900 (957)	15 300 (1054)			
3/4					10 000 (689)	11 300 (778)	12 500 (861)	15 100 (1040)	16 800 (1157)	
1							9 100 (626)	10 300 (709)	12 200 (840)	15 100 (1040)

^① No allowance is made for corrosion, erosion, welding, or elevated temperatures.

Alloy 625 Weld Connections^①

Allowable working pressures are calculated from an S value of 40,000 psi (2766 MPa) for N06625 (grade 1 bar) in accordance with ASME B31.3. Working pressures are for temperatures from -20 to 100°F (-28 to 37°C). See **Elevated Temperature Factors** for ratings above 100°F (37°C).

Tube OD in.	Tube Wall Thickness, in.									
	0.035	0.049	0.065	0.083	0.095	0.109	0.120	0.134	0.156	0.188
	Working Pressure, psig (bar)									
1/4	11 200 (771)	16 400 (1129)	22 100 (1522)							
3/8		10 400 (716)	14 200 (978)	18 600 (1281)	21 600 (1488)					
1/2			10 300 (709)	13 400 (923)	15 700 (1081)	18 400 (1267)				
5/8				10 500 (723)	12 200 (840)	14 300 (985)	15 800 (1088)			
3/4					10 000 (689)	11 700 (806)	12 900 (888)	14 700 (1012)	17 400 (1198)	
1							9 400 (647)	10 600 (730)	12 600 (868)	15 600 (1074)

① No allowance is made for corrosion, erosion, welding, or elevated temperatures.

ST (SAE/MS) End Connection

Pressure ratings are based on SAE J1926/3 at ambient temperature 70°F (20°C).

ST (SAE/MS) Thread Size	Designator	316L SS, Alloy 2507, Alloy 625	
		Non-Positionable	Positionable
		Working Pressure, psig (bar)	
5/16-24	2ST	4568 (314)	4568 (314)
7/16-20	4ST		
1/2-20	5ST		
9/16-18	6ST		3626 (249)
3/4-16	8ST		

Male AN (JIC) End Connections

Pressure ratings are at ambient temperature 70°F (20°C) and apply to slide-on and crimped-on swivel nuts with a female gland.

Male AN (JIC) Thread Size	Designator	316L SS, Alloy 2507, Alloy 625	
		Straight	Shape
		Working Pressure, psig (bar)	
7/16-20	4AN	10 000 (689)	10 000 (689)
9/16-18	6AN	8 200 (564)	7 600 (523)
3/4-16	8AN		

Pressure Ratings

Cone & Thread Tube Nipple Adapter Pressure Rating Basis

Cone & thread tube nipple adapters have pressure ratings for the cone & thread end and for the weld end. The pressure rating for the complete adapter is the lower of the pressure rating of the cone & thread end and the pressure rating of the weld end. Pressure ratings for the cone & thread end are based on ASME B31.3 Process Piping, Chapter IX High Pressure Piping, and for the weld end on ASME B31.3 base code. Working pressures for the cone & thread end are for temperatures from -20 to 100°F (-28 to 37°C).

Fractional Tube OD in.	Cone and Thread End Pressure Rating psig (bar)		
	316L	Alloy 2507	Alloy 625
1/4	10 000 (689)	20 000 (1378)	15 000 (1037)
3/8			
9/16			
3/4			
1			

Elevated Temperature Factors for Weld Fittings

The elevated temperature factors for weld fittings are shown in the following table.

Elevated Temperature Factors for Cone and Thread Tube Nipple Adapters

To determine the pressure rating for a specific cone & thread tube nipple adapter at an elevated temperature, the derated pressure for both ends shall be calculated, using the elevated temperature factors below. The derated pressure of the adapter is the lower of the derated pressure for the cone & thread end and the derated pressure for the weld end.

Temperature		Elevated Temperature Factor for Weld End ^①			Elevated Temperature Factor for Cone and Thread End ^①		
°F	°C	Annealed 316L Barstock and Forging	Annealed Alloy 2507 Barstock and Forging	Annealed Alloy 625 Grade 1 Barstock	Annealed Alloy 316 Barstock and Forging	Annealed Alloy 2507 Barstock and Forging	Annealed Alloy 625 Grade 1 Barstock
		B31.3 Base Code	B31.3 Base Code	B31.3 Base Code	Chapter IX	Chapter IX	Chapter IX
150	66	1.00	1.00	1.00	1.00	1.00	1.00
200	93		0.99			0.98	
250	121		0.96			0.93	
300	149		0.94			0.90	
400	204	0.96	0.91		0.84	0.84	
500	260	0.90	0.89 ^②	0.96	0.78	0.81 ^②	0.98
600	316	0.85	—	0.94	0.74	—	0.95
700	371	0.82			0.71		0.93
800	427	0.80					
900	482	0.78					
1000	538	0.76					

^① Elevated temperature factor = suggested allowable working pressure at elevated temperature / suggested allowable working pressure at room temperature.

^② Alloy 2507 Super Duplex Tubing has a maximum temperature rating of 482°F (250°C)

Pressure Ratings

Elevated Temperature Factors

Multiply the working pressure from the tables provided by the appropriate factor to obtain working pressure at elevated temperatures.

Example: 1/2 in. O.D. annealed 316L union elbow with 0.095 in. wall thickness at 1000°F (537°C):

The working pressure at -20 to 100°F (-28 to 37°C) is 7800 psig (537 bar).

The temperature factor for 316L at 1000°F (537°C) is 0.76:

$7800 \text{ psig (537 bar)} \times 0.76 = 5928 \text{ psig (408 bar)}$.

The allowable working pressure for a 1/2 in. annealed 316L union elbow with 0.095 in. wall thickness at 1000°F (537°C) is 5928 psig (408 bar).

Alloy 2507 Low-Temperature Ratings

Fitting pressure ratings are for metal temperatures from -50 to 100°F (-46 to 37°C), based on -50°F (-46°C) impact tests performed on 2507 bar and forgings.

However, the NORSOK M-001 Materials Selection standard allows this tubing to be used at a minimum temperature of -50°F (-46°C). According to the NORSOK M-630 Material Data Sheets for Piping, 2507 tubing does not have to undergo low-temperature impact testing if wall thicknesses are below 0.236 in. (6 mm).

ASME B31.3 Process Piping requires weld qualification testing for use at temperatures below -20°F (-28°C).

Welding Precautions

- O-rings must be removed prior to welding. Do not clean lubricant off the O-ring. Set the O-ring aside and reinstall after welding is complete and the fitting has cooled. Damage to the O-ring may occur if exposed to the excessive heat of the welding operation.
- Threads must be protected from weld spatter.

Ordering Information

Straights and Elbows - Weld Unions

Straight and elbow weld union ordering numbers follow the sequence shown below.

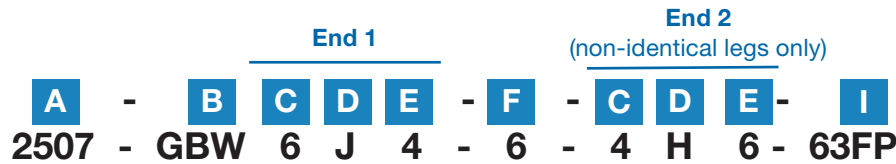

A Material

316L = 316L stainless steel
625 = Alloy 625
2507 = Alloy 2507

B Series

GBW = Subsea tube butt weld
GBJ = Subsea tube butt weld with J-Groove^①

C GBW/J Tube OD, in.

4 = 1/4
6 = 3/8
8 = 1/2
10 = 5/8
12 = 3/4
16 = 1

D GBW/J Wall Thickness, in.

G = 0.035
H = 0.049
J = 0.065
K = 0.083
L = 0.095
M = 0.109
N = 0.120
P = 0.134
Q = 0.156
R = 0.188

E GBW/J Weld Tangent Length, in.

Elbows
 For 1/2, 5/8, 3/4, and 1 in. Tube OD

3 = 0.75
4 = 1.00
5 = 1.25
6 = 1.50
8 = 2.00^②

Elbows
 For 1/4 and 3/8 in. Tube OD

3 = 0.64
4 = 0.89
5 = 1.14
6 = 1.39

Straights
 For all sizes

3 = 0.75
4 = 1.00
5 = 1.25
6 = 1.50
8 = 2.00^②

F Fitting Type

6 = Union, straight
9 = Union, 90° elbow^③

I Options

63 = 63 R_a ID finish
FP = Liquid penetrant examination

① GBJ is only available for wall thicknesses of 0.065 in. and larger. If GBJ option is selected, J-Groove geometry will be machined on all weld ends with a wall thickness of 0.065 in. or larger.

② 2 in. weld tangent length is only available for ODs of 5/8 in. and larger.

③ Available for 316L and alloy 2507 materials only.

Ordering Information

Straights and Elbows - Weld to Male Threads

Straight and elbow weld to male thread connector ordering numbers follow the sequence shown below.

End 1
End 2

A - **B** **C** **D** **E** - **F** - **G** **H** - **I**
2507 - **GBW** **6** **J** **4** - **1** - **6** **AN** - **63FP**

A Material

316L = 316L stainless steel
625 = Alloy 625
2507 = Alloy 2507

B Series

GBW = Subsea tube butt weld
GBJ = Subsea tube butt weld with J-Groove^①

C GBW/J Tube OD, in.

4 = 1/4
6 = 3/8
8 = 1/2
10 = 5/8
12 = 3/4
16 = 1

D GBW/J Wall Thickness, in.

G = 0.035
H = 0.049
J = 0.065
K = 0.083
L = 0.095
M = 0.109
N = 0.120
P = 0.134
Q = 0.156
R = 0.188

E GBW/J Weld Tangent Length, in.

Elbows

For 1/2, 5/8, 3/4, and 1 in. Tube OD

3 = 0.75
4 = 1.00
5 = 1.25
6 = 1.50
8 = 2.00^②

Elbows

For 1/4 and 3/8 in. Tube OD

3 = 0.64
4 = 0.89
5 = 1.14
6 = 1.39

Straights

For all sizes

3 = 0.75
4 = 1.00
5 = 1.25
6 = 1.50
8 = 2.00^②

F Fitting Type

1 = Male connector, straight
2 = 90° elbow^③
1L = Long male connector, straight^⑤

G Second End Connection Size, in.

4 = 1/4^{③④}
6 = 3/8^{③④}
8 = 1/2^③
9 = 9/16^⑤
12 = 3/4^⑤
16 = 1^⑤

H Second End Connection Type

AN = 37° Male AN flare (JIC)
ST = Straight thread with O-ring (SAE/MS)
CW = Cone & thread tube nipple adapter

I Options

63 = 63 R_a ID finish
FP = Liquid penetrant examination
XR = No O-ring

① GBJ is only available for wall thicknesses of 0.065 in. and larger.

② 2 in. weld tangent length is only available for ODs of 5/8 in. and larger.

③ Available for AN or ST connections.

④ Available for CW connections, straight or elbow.

⑤ Available for CW connections, straight only.

⑥ Available for 316L and alloy 2507 materials only.

Ordering Information

Tees - Weld Unions

Tee weld union ordering numbers follow the sequence shown below.

Note: Identical leg tees - insert “3” after first “E” selection to complete ordering number.

A	-	B	End 1			-	F	End 2 (non-identical legs only)			-	End 3 (non-identical legs only)			-	I
A	-	B	C	D	E	-	F	C	D	E	-	C	D	E	-	I
2507	-	GBW	4	G	4	-		6	J	6	-	4	G	4	-	63FP
2507	-	GBW	4	G	4	-	3				-				-	

A Material

316L = 316L stainless steel
2507 = Alloy 2507

B Series

GBW = Subsea tube butt weld
GBJ = Subsea tube butt weld with J-Groove^①

C GBW/J Tube OD, in.

4 = 1/4
6 = 3/8
8 = 1/2
10 = 5/8
12 = 3/4
16 = 1

D GBW/J Wall Thickness, in.

G = 0.035
H = 0.049
J = 0.065
K = 0.083
L = 0.095
M = 0.109
N = 0.120
P = 0.134
Q = 0.156
R = 0.188

E GBW/J Weld Tangent Length, in.

For 1/2, 5/8, 3/4, and 1 in. Tube OD

3 = 0.75
4 = 1.00
5 = 1.25
6 = 1.50
8 = 2.00^②

For 1/4 and 3/8 in. Tube OD

3 = 0.64
4 = 0.89
5 = 1.14
6 = 1.39

F Fitting Type (Identical Legs Only)

3 = Union, tee

I Options

63 = 63 R_a ID finish
FP = Liquid penetrant examination



① GBJ is only available for wall thicknesses of 0.065 in. and larger. If GBJ option is selected, J-Groove geometry will be machined on all weld ends with a wall thickness of 0.065 in. or larger.

② 2 in. weld tangent length is only available for ODs of 5/8 in. and larger.

Dimensions

Dimensions are for reference only and are subject to change.

Straight Fittings

Unions

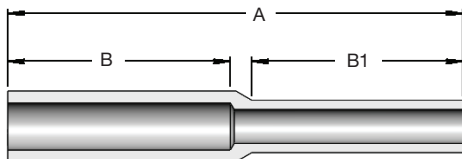

How to Order

Select a basic ordering number and add a material prefix.

Note: GBJ series fittings are only available for wall thicknesses greater than or equal to 0.065 in. GBJ J-Groove geometry will only be applied to the ends with wall thicknesses greater than or equal to 0.065 in.

Basic ordering number shown with the maximum weld tangent length. Refer to page 10 for additional weld tangent lengths.

Additional wall thicknesses are available. Refer to page 10.

Example: Basic ordering number: -GBW8K6-6-4J6
Final ordering number: 2507-GBW8K6-6-4J6

Reducing Union

End 1			End 2			Basic Ordering Number		Dimensions, in. (mm)
Tube OD, in.	Wall Thickness, in.	B Weld Tangent Length, in. (mm)	Tube OD, in.	Wall Thickness, in.	B1 Weld Tangent Length, in. (mm)	GBW	GBJ	A
3/8	0.065	1.50 (38.1)	1/4	0.065	1.50 (38.1)	-GBW6J6-6-4J6	-GBJ6J6-6-4J6	3.24 (82.3)
1/2	0.083	1.50 (38.1)	1/4	0.065	1.50 (38.1)	-GBW8K6-6-4J6	-GBJ8K6-6-4J6	3.35 (85.1)
			3/8	0.065	1.50 (38.1)	-GBW8K6-6-6J6	-GBJ8K6-6-6J6	3.24 (82.3)
5/8	0.083	2.00 (50.8)	3/8	0.065	1.50 (38.1)	-GBW10K8-6-6J6	-GBJ10K8-6-6J6	3.85 (97.8)
			1/2	0.083	1.50 (38.1)	-GBW10K8-6-8K6	-GBJ10K8-6-8K6	3.74 (95.0)
3/4	0.095	2.00 (50.8)	3/8	0.065	1.50 (38.1)	-GBW12L8-6-6J6	-GBJ12L8-6-6J6	3.95 (100)
			1/2	0.083	1.50 (38.1)	-GBW12L8-6-8K6	-GBJ12L8-6-8K6	3.85 (97.8)
			5/8	0.083	2.00 (50.8)	-GBW12L8-6-10K8	-GBJ12L8-6-10K8	4.24 (108)
1	0.156	2.00 (50.8)	1/2	0.083	1.50 (38.1)	-GBW16Q8-6-8K6	-GBJ16Q8-6-8K6	4.06 (103)
			5/8	0.083	2.00 (50.8)	-GBW16Q8-6-10K8	-GBJ16Q8-6-10K8	4.45 (113)
			3/4	0.095	2.00 (50.8)	-GBW16Q8-6-12L8	-GBJ16Q8-6-12L8	4.35 (110)

Additional configurations are available on request. Contact your authorized Swagelok sales and service representative.

Straight Fittings

Male Connectors

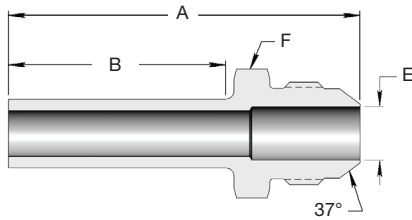

How to Order

Select a basic ordering number and add a material prefix.

Note: GBJ series fittings are only available for wall thicknesses greater than or equal to 0.065 in.

Basic ordering number shown with the maximum weld tangent length. Refer to page 11 for additional weld tangent lengths.

Additional wall thicknesses are available. Refer to page 11.

Example: Basic ordering number: -GBW8K6-1-4AN

Final ordering number: 2507-GBW8K6-1-4AN

AN (JIC)

End 1			End 2		Basic Ordering Number		Dimensions, in. (mm)		
Tube OD, in.	Wall Thickness, in.	B Weld Tangent Length, in. (mm)	AN Tube Flare Size, in.	AN Thread	GBW	GBJ	A	E	F Hex Size
1/4	0.065	1.50 (38.1)	1/4	7/16-20 UNJF-3	-GBW4J6-1-4AN	-GBJ4J6-1-4AN	2.39 (60.7)	0.17 (4.3)	1/2
			3/8	9/16-18 UNJF-3	-GBW4J6-1-6AN	-GBJ4J6-1-6AN	2.43 (61.7)	0.30 (7.6)	5/8
			1/2	3/4-16 UNJF-3	-GBW4J6-1-8AN	-GBJ4J6-1-8AN	2.56 (65.0)	0.39 (9.9)	13/16
3/8	0.065	1.50 (38.1)	1/4	7/16-20 UNJF-3	-GBW6J6-1-4AN	-GBJ6J6-1-4AN	2.39 (60.7)	0.17 (4.3)	1/2
			3/8	9/16-18 UNJF-3	-GBW6J6-1-6AN	-GBJ6J6-1-6AN	2.43 (61.7)	0.30 (7.6)	5/8
			1/2	3/4-16 UNJF-3	-GBW6J6-1-8AN	-GBJ6J6-1-8AN	2.56 (65.0)	0.39 (9.9)	13/16
1/2	0.083	1.50 (38.1)	1/4	7/16-20 UNJF-3	-GBW8K6-1-4AN	-GBJ8K6-1-4AN	2.39 (60.7)	0.17 (4.3)	1/2
			3/8	9/16-18 UNJF-3	-GBW8K6-1-6AN	-GBJ8K6-1-6AN	2.43 (61.7)	0.30 (7.6)	5/8
			1/2	3/4-16 UNJF-3	-GBW8K6-1-8AN	-GBJ8K6-1-8AN	2.56 (65.0)	0.39 (9.9)	13/16
5/8	0.083	2.00 (50.8)	1/4	7/16-20 UNJF-3	-GBW10K8-1-4AN	-GBJ10K8-1-4AN	2.92 (74.2)	0.17 (4.3)	11/16
			3/8	9/16-18 UNJF-3	-GBW10K8-1-6AN	-GBJ10K8-1-6AN	2.93 (74.4)	0.30 (7.6)	11/16
			1/2	3/4-16 UNJF-3	-GBW10K8-1-8AN	-GBJ10K8-1-8AN	3.06 (77.7)	0.39 (9.9)	13/16
3/4	0.095	2.00 (50.8)	1/4	7/16-20 UNJF-3	-GBW12L8-1-4AN	-GBJ12L8-1-4AN	2.95 (74.9)	0.17 (4.3)	13/16
			3/8	9/16-18 UNJF-3	-GBW12L8-1-6AN	-GBJ12L8-1-6AN	2.96 (75.2)	0.30 (7.6)	13/16
			1/2	3/4-16 UNJF-3	-GBW12L8-1-8AN	-GBJ12L8-1-8AN	3.06 (77.7)	0.39 (9.9)	13/16
1	0.156	2.00 (50.8)	1/4	7/16-20 UNJF-3	-GBW16Q8-1-4AN	-GBJ16Q8-1-4AN	2.95 (74.9)	0.17 (4.3)	1 1/16
			3/8	9/16-18 UNJF-3	-GBW16Q8-1-6AN	-GBJ16Q8-1-6AN	2.96 (75.2)	0.30 (7.6)	1 1/16
			1/2	3/4-16 UNJF-3	-GBW16Q8-1-8AN	-GBJ16Q8-1-8AN	3.06 (77.7)	0.39 (9.9)	1 1/16

Additional configurations are available on request. Contact your authorized Swagelok sales and service representative.

Straight Fittings

Male Connectors

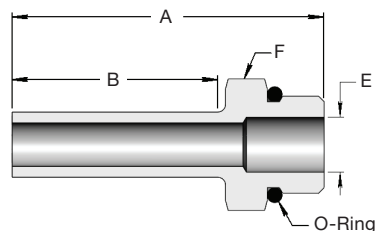

Adapts to SAE J1926/1 and ISO 11926-1 straight thread boss.

How to Order

Select a basic ordering number and add a material prefix.

Note: GBJ series fittings are only available for wall thicknesses greater than or equal to 0.065 in.

Basic ordering number shown with the maximum weld tangent length. Refer to page 11 for additional weld tangent lengths.

Additional wall thicknesses are available. Refer to page 11.

Example: Basic ordering number: -GBW8K6-1-4ST

Final ordering number: 2507-GBW8K6-1-4ST

SAE/MS Straight Thread (ST), Non-Positionable

End 1			End 2	Basic Ordering Number		Dimensions, in. (mm)		
Tube OD, in.	Wall Thickness, in.	B Weld Tangent Length, in. (mm)	SAE/MS Thread Size	GBW	GBJ	A	E	F Hex Size
1/4	0.065	1.50 (38.1)	7/16-20	-GBW4J6-1-4ST	-GBJ4J6-1-4ST	2.20 (55.9)	0.20 (5.1)	9/16
			9/16-18	-GBW4J6-1-6ST	-GBJ4J6-1-6ST	2.26 (57.4)	0.28 (7.1)	11/16
			3/4-16	-GBW4J6-1-8ST	-GBJ4J6-1-8ST	2.34 (59.4)	0.42 (10.7)	7/8
3/8	0.065	1.50 (38.1)	7/16-20	-GBW6J6-1-4ST	-GBJ6J6-1-4ST	2.20 (55.9)	0.20 (5.1)	9/16
			9/16-18	-GBW6J6-1-6ST	-GBJ6J6-1-6ST	2.26 (57.4)	0.28 (7.1)	11/16
			3/4-16	-GBW6J6-1-8ST	-GBJ6J6-1-8ST	2.34 (59.4)	0.42 (10.7)	7/8
1/2	0.083	1.50 (38.1)	7/16-20	-GBW8K6-1-4ST	-GBJ8K6-1-4ST	2.20 (55.9)	0.20 (5.1)	9/16
			9/16-18	-GBW8K6-1-6ST	-GBJ8K6-1-6ST	2.26 (57.4)	0.28 (7.1)	11/16
			3/4-16	-GBW8K6-1-8ST	-GBJ8K6-1-8ST	2.34 (59.4)	0.42 (10.7)	7/8
5/8	0.083	2.00 (50.8)	7/16-20	-GBW10K8-1-4ST	-GBJ10K8-1-4ST	2.73 (69.3)	0.20 (5.1)	11/16
			9/16-18	-GBW10K8-1-6ST	-GBJ10K8-1-6ST	2.76 (70.1)	0.28 (7.1)	11/16
			3/4-16	-GBW10K8-1-8ST	-GBJ10K8-1-8ST	2.84 (72.1)	0.42 (10.7)	7/8
3/4	0.095	2.00 (50.8)	7/16-20	-GBW12L8-1-4ST	-GBJ12L8-1-4ST	2.76 (70.1)	0.20 (5.1)	13/16
			9/16-18	-GBW12L8-1-6ST	-GBJ12L8-1-6ST	2.79 (70.9)	0.28 (7.1)	13/16
			3/4-16	-GBW12L8-1-8ST	-GBJ12L8-1-8ST	2.84 (72.1)	0.42 (10.7)	7/8
1	0.156	2.00 (50.8)	7/16-20	-GBW16Q8-1-4ST	-GBJ16Q8-1-4ST	2.76 (70.1)	0.20 (5.1)	1 1/16
			9/16-18	-GBW16Q8-1-6ST	-GBJ16Q8-1-6ST	2.79 (70.9)	0.28 (7.1)	1 1/16
			3/4-16	-GBW16Q8-1-8ST	-GBJ16Q8-1-8ST	2.84 (72.1)	0.42 (10.7)	1 1/16

Additional configurations are available on request. Contact your authorized Swagelok sales and service representative.

Straight Fittings

Male Connectors

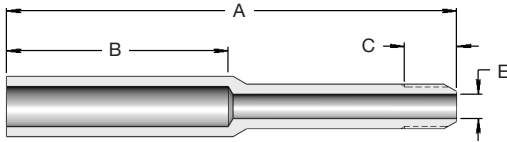

How to Order

Select a basic ordering number and add a material prefix.

Note: GBJ series fittings are only available for wall thicknesses greater than or equal to 0.065 in.

Basic ordering number shown with the maximum weld tangent length. Refer to page 11 for additional weld tangent lengths.

Additional wall thicknesses are available. Refer to page 11.

If using an antivibration gland, replace “-1-” with “-1L-” (long cone and thread tube nipple adapter required).

Example: Basic ordering number: -GBW8K6-1-9CW

Final ordering number: 2507-GBW8K6-1-9CW

Cone & Thread Tube Nipple Adapters

End 1			End 2		Basic Ordering Number		Dimensions, in. (mm)		
Tube OD, in.	Wall Thickness, in.	B Weld Tangent Length, in. (mm)	CW Size, in.	CW Thread Size	GBW	GBJ	A	C CW Thread Length	E
1/4	0.065	1.50 (38.1)	1/4	1/4-28 LH	-GBW4J6-1-4CW	-GBJ4J6-1-4CW	2.99 (75.9)	0.34 (8.6)	0.11 (2.8)
			3/8	3/8-24 LH	-GBW4J6-1-6CW	-GBJ4J6-1-6CW	3.47 (88.1)	0.44 (11.2)	0.20 (5.1)
			9/16	9/16-18 LH	-GBW4J6-1-9CW	-GBJ4J6-1-9CW	4.04 (103)	0.50 (12.7)	0.31 (7.9)
3/8	0.065	1.50 (38.1)	1/4	1/4-28 LH	-GBW6J6-1-4CW	-GBJ6J6-1-4CW	3.10 (78.7)	0.34 (8.6)	0.11 (2.8)
			3/8	3/8-24 LH	-GBW6J6-1-6CW	-GBJ6J6-1-6CW	3.30 (83.8)	0.44 (11.2)	0.20 (5.1)
			9/16	9/16-18 LH	-GBW6J6-1-9CW	-GBJ6J6-1-9CW	3.93 (99.8)	0.50 (12.7)	0.31 (7.9)
			3/4	3/4-16 LH	-GBW6J6-1-12CW	-GBJ6J6-1-12CW	4.14 (105)	0.62 (15.7)	0.43 (10.9)
1/2	0.083	1.50 (38.1)	3/8	3/8-24 LH	-GBW8K6-1-6CW	-GBJ8K6-1-6CW	3.41 (86.6)	0.44 (11.2)	0.20 (5.1)
			9/16	9/16-18 LH	-GBW8K6-1-9CW	-GBJ8K6-1-9CW	3.82 (97.0)	0.50 (12.7)	0.31 (7.9)
			3/4	3/4-16 LH	-GBW8K6-1-12CW	-GBJ8K6-1-12CW	4.03 (102)	0.62 (15.7)	0.43 (10.9)
			1	1-14 LH	-GBW8K6-1-16CW	-GBJ8K6-1-16CW	5.05 (128)	0.78 (19.8)	0.56 (14.2)
5/8	0.083	2.00 (50.8)	3/8	3/8-24 LH	-GBW10K8-1-6CW	-GBJ10K8-1-6CW	4.02 (102)	0.44 (11.2)	0.20 (5.1)
			9/16	9/16-18 LH	-GBW10K8-1-9CW	-GBJ10K8-1-9CW	4.26 (108)	0.50 (12.7)	0.31 (7.9)
			3/4	3/4-16 LH	-GBW10K8-1-12CW	-GBJ10K8-1-12CW	4.42 (112)	0.62 (15.7)	0.43 (10.9)
			1	1-14 LH	-GBW10K8-1-16CW	-GBJ10K8-1-16CW	5.44 (138)	0.78 (19.8)	0.56 (14.2)
3/4	0.095	2.00 (50.8)	3/8	3/8-24 LH	-GBW12L8-1-6CW	-GBJ12L8-1-6CW	4.13 (105)	0.44 (11.2)	0.20 (5.1)
			9/16	9/16-18 LH	-GBW12L8-1-9CW	-GBJ12L8-1-9CW	4.37 (111)	0.50 (12.7)	0.31 (7.9)
			3/4	3/4-16 LH	-GBW12L8-1-12CW	-GBJ12L8-1-12CW	4.25 (108)	0.62 (15.7)	0.43 (10.9)
			1	1-14 LH	-GBW12L8-1-16CW	-GBJ12L8-1-16CW	5.33 (135)	0.78 (19.8)	0.56 (14.2)
1	0.156	2.00 (50.8)	9/16	9/16-18 LH	-GBW16Q8-1-9CW	-GBJ16Q8-1-9CW	4.58 (116)	0.50 (12.7)	0.31 (7.9)
			3/4	3/4-16 LH	-GBW16Q8-1-12CW	-GBJ16Q8-1-12CW	4.47 (114)	0.62 (15.7)	0.43 (10.9)
			1	1-14 LH	-GBW16Q8-1-16CW	-GBJ16Q8-1-16CW	5.05 (128)	0.78 (19.8)	0.56 (14.2)

To protect surfaces from galling at installation, apply a system-compatible lubricant to the nose and threads of the coned end.

Additional configurations are available on request. Contact your authorized Swagelok sales and service representative.

90° Elbows

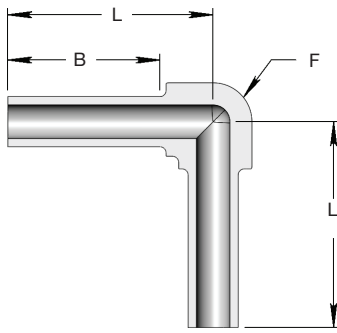

How to Order

Select a basic ordering number and add a material prefix.

Note: GBJ series fittings are only available for wall thicknesses greater than or equal to 0.065 in.

Basic ordering number shown with the maximum weld tangent length. Refer to page 10 for additional weld tangent lengths.

Additional wall thicknesses are available. Refer to page 10.

Example: Basic ordering number: -GBW8K6-9

Final ordering number: 2507-GBW8K6-9

Note: Shape fittings (elbows and tees) are available for 316L and alloy 2507 materials only.

Union

Tube OD, in.	Wall Thickness, in.	B Weld Tangent Length, in. (mm)	Basic Ordering Number		Dimensions, in. (mm)	
			GBW	GBJ	F Wrench Pad Size	L
1/4	0.065	0.89 (22.6)	-GBW4J6-9	-GBJ4J6-9	11/16	1.97 (50.0)
3/8	0.065	1.39 (35.3)	-GBW6J6-9	-GBJ6J6-9	11/16	1.97 (50.0)
1/2	0.083	1.50 (38.1)	-GBW8K6-9	-GBJ8K6-9	11/16	2.10 (53.3)
5/8	0.083	2.00 (50.8)	-GBW10K8-9	-GBJ10K8-9	15/16	2.73 (69.3)
3/4	0.095	2.00 (50.8)	-GBW12L8-9	-GBJ12L8-9	15/16	2.73 (69.3)
1	0.156	2.00 (50.8)	-GBW16Q8-9	-GBJ16Q8-9	1 1/4	2.86 (72.6)

Additional configurations are available on request. Contact your authorized Swagelok sales and service representative.

90° Elbows

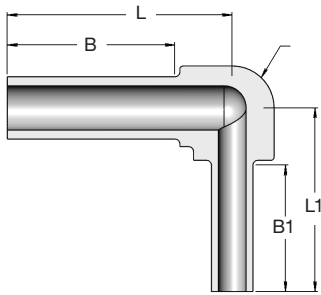

How to Order

Select a basic ordering number and add a material prefix.

Note: GBJ series fittings are only available for wall thicknesses greater than or equal to 0.065 in. GBJ J-Groove geometry will only be applied to the ends with wall thicknesses greater than or equal to 0.065 in.

Basic ordering number shown with the maximum weld tangent length. Refer to page 10 for additional weld tangent lengths.

Additional wall thicknesses are available. Refer to page 10.

Example: Base ordering number: GBW8K6-9-6J6

Final ordering number: 2507-GBW8K6-9-6J6

Note: Shape fittings (elbows and tees) are available for 316L and alloy 2507 materials only.

Reducing Union

End 1			End 2			Basic Ordering Number		Dimensions, in. (mm)		
Tube OD, in.	Wall Thickness, in.	B Weld Tangent Length, in. (mm)	Tube OD, in.	Wall Thickness, in.	B1 Weld Tangent Length, in. (mm)	GBW	GBJ	F Wrench Pad Size	L	L1
3/8	0.065	1.39 (35.3)	1/4	0.065	0.89 (22.6)	-GBW6J6-9-4J6	-GBJ6J6-9-4J6	11/16	1.97 (50.0)	1.97 (50.0)
1/2	0.083	1.50 (38.1)	1/4	0.065	0.89 (22.6)	-GBW8K6-9-4J6	-GBJ8K6-9-4J6	11/16	2.10 (53.3)	2.10 (53.3)
			3/8	0.065	1.39 (35.3)	-GBW8K6-9-6J6	-GBJ8K6-9-6J6	11/16	2.10 (53.3)	2.10 (53.3)
5/8	0.083	2.00 (50.8)	3/8	0.065	1.50 (38.1)	-GBW10K8-9-6J6	-GBJ10K8-9-6J6	15/16	2.73 (69.3)	2.23 (56.6)
			1/2	0.083	1.50 (38.1)	-GBW10K8-9-8K6	-GBJ10K8-9-8K6	15/16	2.73 (69.3)	2.23 (56.6)
3/4	0.095	2.00 (50.8)	3/8	0.065	1.50 (38.1)	-GBW12L8-9-6J6	-GBJ12L8-9-6J6	15/16	2.73 (69.3)	2.23 (56.6)
			1/2	0.083	1.50 (38.1)	-GBW12L8-9-8K6	-GBJ12L8-9-8K6	15/16	2.73 (69.3)	2.23 (56.6)
			5/8	0.083	2.00 (50.8)	-GBW12L8-9-10K8	-GBJ12L8-9-10K8	15/16	2.73 (69.3)	2.73 (69.3)
1	0.156	2.00 (50.8)	1/2	0.083	2.00 (50.8)	-GBW16Q8-9-8K6	-GBJ16Q8-9-8K6	1 1/4	2.86 (72.6)	2.36 (59.9)
			5/8	0.083	2.00 (50.8)	-GBW16Q8-9-10K8	-GBJ16Q8-9-10K8	1 1/4	2.86 (72.6)	2.86 (72.6)
			3/4	0.095	2.00 (50.8)	-GBW16Q8-9-12L8	-GBJ16Q8-9-12L8	1 1/4	2.86 (72.6)	2.86 (72.6)

Additional configurations are available on request. Contact your authorized Swagelok sales and service representative.

Tees

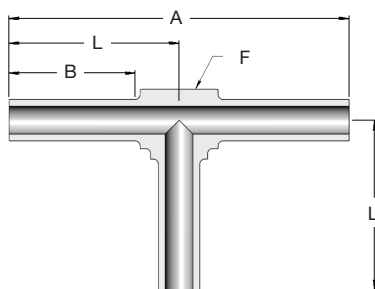

How to Order

Select a basic ordering number and add a material prefix.

Note: GBJ series fittings are only available for wall thicknesses greater than or equal to 0.065 in.

Basic ordering number shown with the maximum weld tangent length. Refer to page 12 for additional weld tangent lengths.

Additional wall thicknesses are available. Refer to page 12.

Example: Base ordering number: -GBW8K6-3

Final ordering number: 2507-GBW8K6-3

Note: Shape fittings (elbows and tees) are available for 316L and alloy 2507 materials only.

Union

Tube OD, in.	Wall Thickness, in.	B Weld Tangent Length, in. (mm)	Basic Ordering Number		Dimensions, in. (mm)		
			GBW	GBJ	A	F Wrench Pad Size	L
1/4	0.065	0.89 (22.6)	-GBW4J6-3	-GBJ4J6-3	3.94 (100)	11/16	1.97 (50.0)
3/8	0.065	1.39 (35.3)	-GBW6J6-3	-GBJ6J6-3	3.94 (100)	11/16	1.97 (50.0)
1/2	0.083	1.50 (38.1)	-GBW8K6-3	-GBJ8K6-3	4.20 (107)	11/16	2.10 (53.3)
5/8	0.083	2.00 (50.8)	-GBW10K8-3	-GBJ10K8-3	5.46 (139)	15/16	2.73 (69.3)
3/4	0.095	2.00 (50.8)	-GBW12L8-3	-GBJ12L8-3	5.46 (139)	15/16	2.73 (69.3)
1	0.156	2.00 (50.8)	-GBW16Q8-3	-GBJ16Q8-3	5.72 (145)	1 1/4	2.86 (72.6)

Additional configurations are available on request. Contact your authorized Swagelok sales and service representative.

Tees

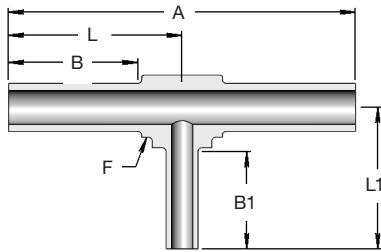

How to Order

Select a basic ordering number and add a material prefix.

Note: GBJ series fittings are only available for wall thicknesses greater than or equal to 0.065 in. GBJ J-Groove geometry will only be applied to the ends with wall thicknesses greater than or equal to 0.065 in.

Basic ordering number shown with the maximum weld tangent length. Refer to page 12 for additional weld tangent lengths.

Additional wall thicknesses are available. Refer to page 12.

Example: Basic ordering number: -GBW8K6-8K6-4J6
Final ordering number: 2507-GBW8K6-8K6-4J6

Note: Shape fittings (elbows and tees) are available for 316L and alloy 2507 materials only.

Reducing Tee - Branch

End 1			End 2			End 3			Basic Ordering Number		Dimensions, in (mm).			
Tube OD, in.	Wall Thickness, in.	B Weld Tangent Length, in. (mm)	Tube OD, in.	Wall Thickness, in.	B Weld Tangent Length, in. (mm)	Tube OD, in.	Wall Thickness, in.	B1 Weld Tangent Length, in. (mm)	GBW	GBJ	A	F Wrench Pad Size	L	L1
3/8	0.065	1.39 (35.3)	3/8	0.065	1.39 (35.3)	1/4	0.065	0.89 (22.6)	-GBW6J6-6J6-4J6	-GBJ6J6-6J6-4J6	3.94 (100)	11/16	1.97 (50.0)	1.97 (50.0)
1/2	0.083	1.50 (38.1)	1/2	0.083	1.50 (38.1)	1/4	0.065	0.89 (22.6)	-GBW8K6-8K6-4J6	-GBJ8K6-8K6-4J6	4.20 (107)	11/16	2.10 (53.3)	2.10 (53.3)
						3/8	0.065	1.39 (35.3)	-GBW8K6-8K6-6J6	-GBJ8K6-8K6-6J6	4.20 (107)	11/16	2.10 (53.3)	2.10 (53.3)
5/8	0.083	2.00 (50.8)	5/8	0.083	2.00 (50.8)	3/8	0.065	1.50 (38.1)	-GBW10K8-10K8-6J6	-GBJ10K8-10K8-6J6	5.46 (139)	15/16	2.73 (69.3)	2.23 (56.6)
						1/2	0.083	1.50 (38.1)	-GBW10K8-10K8-8K6	-GBJ10K8-10K8-8K6	5.46 (139)	15/16	2.73 (69.3)	2.23 (56.6)
3/4	0.095	2.00 (50.8)	3/4	0.095	2.00 (50.8)	3/8	0.065	1.50 (38.1)	-GBW12L8-12L8-6J6	-GBJ12L8-12L8-6J6	5.46 (139)	15/16	2.73 (69.3)	2.23 (56.6)
						1/2	0.083	1.50 (38.1)	-GBW12L8-12L8-8K6	-GBJ12L8-12L8-8K6	5.46 (139)	15/16	2.73 (69.3)	2.23 (56.6)
						5/8	0.083	2.00 (50.8)	-GBW12L8-12L8-10K8	-GBJ12L8-12L8-10K8	5.46 (139)	15/16	2.73 (69.3)	2.73 (69.3)
1	0.156	2.00 (50.8)	1	0.156	2.00 (50.8)	1/2	0.083	1.50 (38.1)	-GBW16Q8-16Q8-8K6	-GBJ16Q8-16Q8-8K6	5.72 (145)	1 1/4	2.86 (72.6)	2.36 (59.9)
						5/8	0.083	2.00 (50.8)	-GBW16Q8-16Q8-10K8	-GBJ16Q8-16Q8-10K8	5.72 (145)	1 1/4	2.86 (72.6)	2.86 (72.6)
						3/4	0.095	2.00 (50.8)	-GBW16Q8-16Q8-12L8	-GBJ16Q8-16Q8-12L8	5.72 (145)	1 1/4	2.86 (72.6)	2.86 (72.6)

Additional configurations are available on request. Contact your authorized Swagelok sales and service representative.

Tees

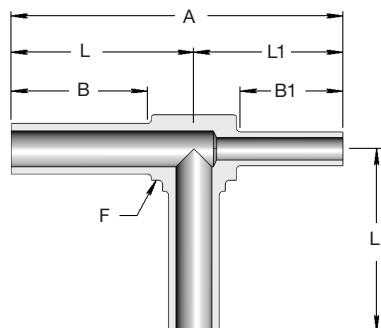

How to Order

Select a basic ordering number and add a material prefix.

Note: GBJ series fittings are only available for wall thicknesses greater than or equal to 0.065 in. GBJ J-Groove geometry will only be applied to the ends with wall thicknesses greater than or equal to 0.065 in.

Basic ordering number shown with the maximum weld tangent length. Refer to page 12 for additional weld tangent lengths.

Additional wall thicknesses are available. Refer to page 12.

Example: Basic ordering number: -GBW8K6-4J6-8K6
Final ordering number: 2507-GBW8K6-4J6-8K6

Note: Shape fittings (elbows and tees) are available for 316L and alloy 2507 materials only.

Reducing Tee - Run

End 1			End 2			End 3			Basic Ordering Number		Dimensions, in. (mm)			
Tube OD, in.	Wall Thickness, in.	B Weld Tangent Length, in. (mm)	Tube OD, in.	Wall Thickness, in.	B1 Weld Tangent Length, in. (mm)	Tube OD, in.	Wall Thickness, in.	B Weld Tangent Length, in. (mm)	GBW	GBJ	A	F Wrench Pad Size	L	L1
3/8	0.065	1.39 (35.3)	1/4	0.065	0.89 (22.6)	3/8	0.065	1.39 (35.3)	-GBW6J6-4J6-6J6	-GBJ6J6-4J6-6J6	3.94 (100)	11/16	1.97 (50.0)	1.97 (50.0)
1/2	0.083	1.50 (38.1)	1/4	0.065	0.89 (22.6)	1/2	0.083	1.50 (38.1)	-GBW8K6-4J6-8K6	-GBJ8K6-4J6-8K6	4.20 (107)	11/16	2.10 (53.3)	2.10 (53.3)
			3/8	0.065	1.39 (35.3)				-GBW8K6-6J6-8K6	-GBJ8K6-6J6-8K6	4.20 (107)	11/16	2.10 (53.3)	2.10 (53.3)
5/8	0.083	2.00 (50.8)	3/8	0.065	1.50 (38.1)	5/8	0.083	2.00 (50.8)	-GBW10K8-6J6-10K8	-GBJ10K8-6J6-10K8	4.96 (126)	15/16	2.73 (69.3)	2.23 (56.6)
			1/2	0.083	1.50 (38.1)				-GBW10K8-8K6-10K8	-GBJ10K8-8K6-10K8	4.96 (126)	15/16	2.73 (69.3)	2.23 (56.6)
3/4	0.095	2.00 (50.8)	3/8	0.065	1.50 (38.1)	3/4	0.095	2.00 (50.8)	-GBW12L8-6J6-12L8	-GBJ12L8-6J6-12L8	4.96 (126)	15/16	2.73 (69.3)	2.23 (56.6)
			1/2	0.083	1.50 (38.1)				-GBW12L8-8K6-12L8	-GBJ12L8-8K6-12L8	4.96 (126)	15/16	2.73 (69.3)	2.23 (56.6)
			5/8	0.083	2.00 (50.8)				-GBW12L8-10K8-12L8	-GBJ12LS8-10K8-12L8	5.46 (139)	15/16	2.73 (69.3)	2.73 (69.3)
1	0.156	2.00 (50.8)	1/2	0.083	1.50 (38.1)	1	0.156	2.00 (50.8)	-GBW16Q8-8K6-16Q8	-GBJ16Q8-8K6-16Q8	5.22 (133)	1 1/4	2.86 (72.6)	2.36 (59.9)
			5/8	0.083	2.00 (50.8)				-GBW16Q8-10K8-16Q8	-GBJ16Q8-10K8-16Q8	5.72 (145)	1 1/4	2.86 (72.6)	2.86 (72.6)
			3/4	0.095	2.00 (50.8)				-GBW16Q8-12L8-16Q8	-GBJ16Q8-12L8-16Q8	5.72 (145)	1 1/4	2.86 (72.6)	2.86 (72.6)

Installation Instructions

O-Seal Male Connectors (ST)

1. Turn the O-seal connector into the female end until it is finger-tight.
2. Tighten the O-seal connector until it makes metal-to-metal contact with the face of the female end.
3. Tighten slightly with a wrench.

AN (JIC) with Swivel Nut

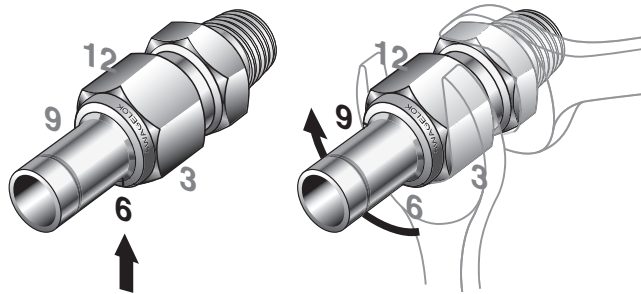

1. Thread the AN swivel nut of the female AN assembly onto the male AN body until it is finger-tight.
2. Mark a line along the AN swivel nut and male AN body, parallel with the axis of the assembly, at the 6 o'clock position.
3. Hold the male AN body steady and tighten the AN swivel nut with a wrench one-quarter turn past finger tight, to the 9 o'clock position.

Note: For carbon steel fittings, assemble nut to finger-tight, then tighten to torque according to SAE J514, *Hydraulic Tube Fittings*.

Reassembly instructions:

There are a maximum of 10 re-assemblies per SAE J514.

1. Prior to disassembly, mark a line along the AN swivel nut and male AN body, parallel with the axis of the assembly.
2. For reassembly, rotate the nut with a wrench to the previously pulled-up position, as indicated by the marks on the AN swivel nut and male AN body. At this point, you will feel a significant increase in resistance. Tighten the nut slightly.

Medium-Pressure Cone & Thread Fitting Assembly Using a Cone & Thread Tube Nipple Adapter

1. Lubricate all male threads with an anti-seize lubricant, such as a Swagelok Goop™ product. Lubricate the cone end of the C&T tube nipple adapter with a system-compatible lubricant.

NOTE: Anti-vibration collet bodies and gland nuts containing dry film lubricant applied at the factory do not need additional lubrication.

2. For standard fittings, slide the C&T tube nipple adapter into the gland (Fig. 1). For anti-vibration option (see Fig. 7 below) slide anti-vibration gland nut and collet onto C&T tube nipple adapter.

For medium-pressure anti-vibration fittings, slide the anti-vibration collet body onto adapter.

Note: Ensure proper orientation of collet body. The tapered face the collet body mates with the collet.

3. Thread the collar counterclockwise (left-hand thread) onto the C&T tube nipple adapter (Fig. 2).
4. Continue threading until 1 to 2 full threads are exposed at the cone end of the C&T tube nipple adapter. This will indicate proper position of the collar (Fig. 3).
5. Insert the C&T tube nipple adapter with the collar into the fitting body (Fig. 4).

6. Make sure the cone end of the tube nipple adapter rests firmly on the angled seat of the fitting body (Fig. 5).
7. For standard fittings, thread the gland into the fitting body until finger tight. Hold the fitting body steady and tighten the gland (Fig. 6) to the required torque.

For medium-pressure anti-vibration fittings, thread the anti-vibration collet body into the fitting body until finger tight. Tighten the anti-vibration collet body the specified torque. Then thread the anti-vibration gland nut onto the anti-vibration collet body until finger tight. Tighten the anti-vibration gland nut to the required torque. The collet will grip the C&T tube nipple adapter when the anti-vibration gland nut is tightened.

Medium-Pressure C&T Fitting

Fitting Size in.	Required Torque, ft-lb (N·m)	
	316 SS and Alloy 2507	Alloy 625
1/4	20 (27.2)	15 (20.3)
3/8	30 (40.7)	25 (33.9)
9/16	55 (74.6)	40 (54.2)
3/4	90 (123)	70 (94.9)
1	150 (204)	115 (156)

These figures apply to 1/4, 3/8, 9/16, 3/4, and 1 in. medium-pressure cone and thread fitting sizes.

Fig. 1

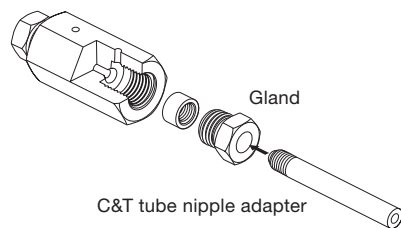

Fig. 2

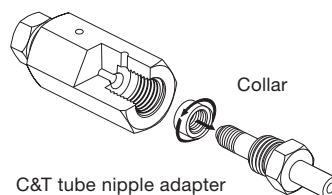

Fig. 3

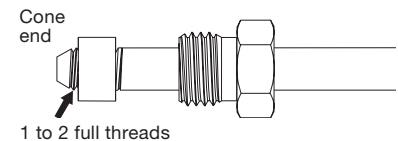

Fig. 4

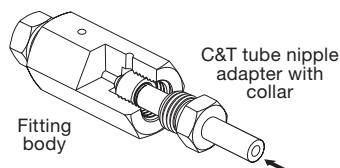

Fig. 5

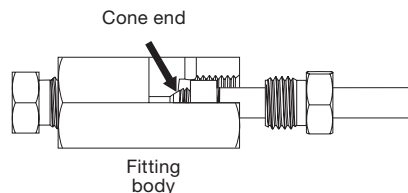

Fig. 6

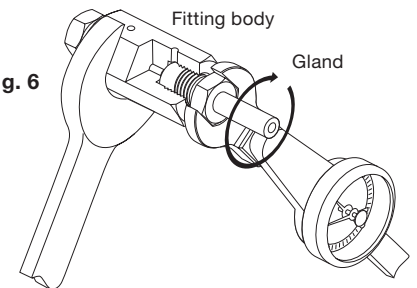
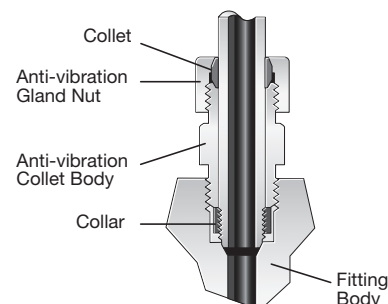

Fig. 7

C&T Tube Nipple Adapter



Compatibility of Cone & Thread Tube Nipple Adapter End Connection (CW)

The cone and thread tube nipple adapter end connections (CW) in this catalog may be assembled with Swagelok IPT series medium-pressure cone and thread fittings or fittings from other manufacturers who follow the dimensions referenced in the table below.

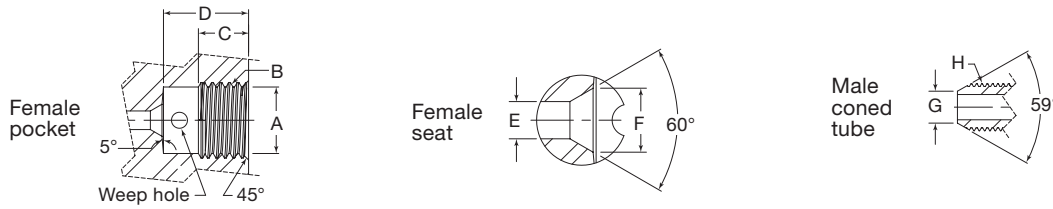

Fitting Size in.	Dimensions, in. (mm)								Tube Engagement Length
	A	B	C	D	E	F	G	H	
Medium Pressure									
1/4	0.39 (9.9)	7/16-20	0.28 (7.1)	0.50 (12.7)	0.11 (2.8)	0.19 (4.6)	0.14 (3.6)	1/4-28	0.56 (14.2)
3/8	0.52 (13.2)	9/16-18	0.38 (9.7)	0.63 (16.0)	0.20 (5.1)	0.31 (7.9)	0.25 (6.4)	3/8-24	0.69 (17.5)
9/16	0.75 (19.0)	13/16-16	0.44 (11.2)	0.75 (19.0)	0.31 (7.9)	0.50 (12.7)	0.41 (10.4)	9/16-18	0.84 (21.3)
3/4	0.95 (24.1)	3/4-14 NPSM	0.70 (17.8)	0.94 (23.9)	0.44 (11.2)	0.63 (16.0)	0.56 (14.2)	3/4-16	1.00 (25.4)
1	1.30 (33.0)	1 3/8-12	0.81 (20.6)	1.31 (33.3)	0.56 (14.2)	0.88 (22.4)	0.72 (18.3)	1-14	1.47 (37.3)

Dimensions are for reference only and are subject to change.

⚠ CAUTION: When interchanging anti-vibration glands, it is recommended to install per the gland manufacturer's instructions.

Related Products

Medium- and High-Pressure Fittings, Tubing, Valves, and Accessories

Swagelok offers a complete line of medium- and high-pressure products. Refer to *Medium- and High-Pressure Fittings, Tubing, Valves and Accessories* catalog, [MS-02-472](#), for additional information.

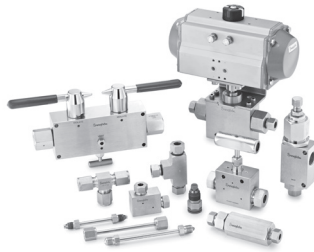

Gaugeable Tube Fittings and Adapter Fittings

Refer to *Gaugeable Tube Fittings and Adapter Fittings* catalog, [MS-01-140](#), for additional information.



Medium- and High- Pressure Fittings and Adapters - Alloy Materials

Refer to *Medium- and High-Pressure Fittings and Adapters—Alloy Materials* catalog, [MS-02-474](#), for additional information.

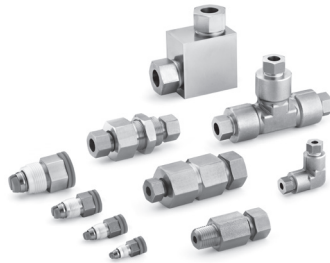

Alloy 2507 Tube Fitting

Refer to *Gaugeable Alloy 2507 Super Duplex Tube Fittings* catalog, [MS-01-174](#), for additional information.



Stainless Steel Tubing

Refer to *Stainless Steel Seamless Tubing and Tube Support System* catalog, [MS-01-181](#), for additional information.

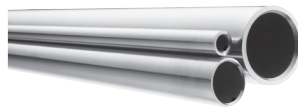

Alloy 2507 Tubing

Refer to *Alloy 2507 Seamless Super Duplex Tubing — Fractional Sizes* catalog, [MS-02-151](#), for additional information.



Tools for Use with Subsea Weld Fittings



Swagelok Welding System

The Swagelok welding system is a powerful (up to 200 A) gas-tungsten arc orbital welding system. Compared to manual or filler-based welding methods for Alloy 2507 material, this autogenous orbital welding system can reduce weld cycle time, improve weld consistency and quality, and help manage the total welding process. The Swagelok welding system is supported by a comprehensive package of equipment, training, accessories, and technical service.

Refer to *Welding System—M200 Power Supply* catalog, [MS-02-342](#), for additional information.

Welding Flux

Swagelok welding flux is required in the autogenous Alloy 2507 welding process developed for use with the Swagelok welding system. The flux helps to ensure that proper austenite/ferrite phase balance, nitrogen content, and weld penetration are achieved in welded Alloy 2507 connections.



Ordering number:
SWS-FLUX-1



Tube Facing Tools

Swagelok TF series tube facing tools machine the smooth, square, burr-free tube ends needed for maximum reliability and performance in orbitally welded and mechanical fitting connections.

Refer to *Tube Facing Tools* catalog, [MS-02-426](#), for additional information.

Safe Product Selection

When selecting a product, the total system design must be considered to ensure safe, trouble-free performance. Function, material compatibility, adequate ratings, proper installation, operation, and maintenance are the responsibilities of the system designer and user.

⚠️ WARNING

Do not mix/interchange Swagelok products or components not governed by industrial design standards, including Swagelok tube fitting end connections, with those of other manufacturers.

Warranty Information

Swagelok products are backed by The Swagelok Limited Lifetime Warranty. For a copy, visit swagelok.com or contact your authorized Swagelok representative.