

Quick-Connects



QC, QF, QM, and QTM Series

- No twisting, turning, or wrenching necessary
- Single-end shutoff, double-end shutoff, and full-flow models

Contents

Instrumentation Quick-Connects

QC Series (Standard and Keyed) 3



Miniature Quick-Connects

QM Series 13



Full-Flow Quick-Connects

QF Series 9



PTFE-Sealed Quick-Connects

QTM Series (Standard and Keyed) 15



Swagelok® Quick-Connects

Coupling

Any quick-connect stem will fit any quick-connect body of the same series and size.

Examples: Any QC4 stem will fit any QC4 body.
Any QC8 stem will fit any QC8 body.

Single- and Double-End Shutoff Stems

Single-end shutoff (SESO) stems have no valves and remain open when uncoupled.

Double-end shutoff (DESO) stems have valves and shut off when uncoupled.

Spillage

Spillage is the amount of system fluid that escapes when a quick-connect is uncoupled (DESO only).

Air Inclusion

Air inclusion is the amount of air trapped between the body and stem that enters the system when a quick-connect is coupled (DESO only).

Flow Coefficient (C_v)

C_v is an average value and may vary $\pm 10\%$. C_v is based on like end connections on stem and body. For unlike end connections, average the two C_v values.

End Connections

Additional end connections—such as ISO parallel and tapered thread, AN thread, pipe weld—are available. Where these end connections are not listed, a tube adapter can be used to create a two-piece assembly. For more information on tube adapters, see the Swagelok *Gaugeable Tube Fittings and Adapter Fittings* catalog, [MS-01-140](#).



Operation of Swagelok Quick-Connects

- Use filters ahead of quick-connects.
- Use body and stem protectors or dust caps on uncoupled bodies and stems.
- Align bodies and stems when coupling or uncoupling.
- Couple and uncouple quick-connects at room temperature.
- Couple and uncouple quick-connects during system cleaning operations.
- Support hanging hoses or other equipment to prevent side load.
- Relubricate stem seal O-rings periodically.

⚠ Warning:

- Pressure rating restrictions apply when coupling and uncoupling.
- Do not uncouple single-end shutoff quick-connects under pressure.

Caution:

- Do not rotate quick-connects while coupled.
- Do not insert foreign objects into uncoupled bodies or stems.

Instrumentation Quick-Connects QC Series

Features

- Redesigned stem insert requires just one O-ring seal, yet improves O-ring containment.
- New-design stems and bodies interchange with old-design stems and bodies.
- Locking dog mechanism with large contact area retains stem.
- Push-to-connect coupling enables quick, easy operation.
- Wide variety of options, including keyed quick-connects, are available.
- Heavy-duty sleeve shields open end of body.

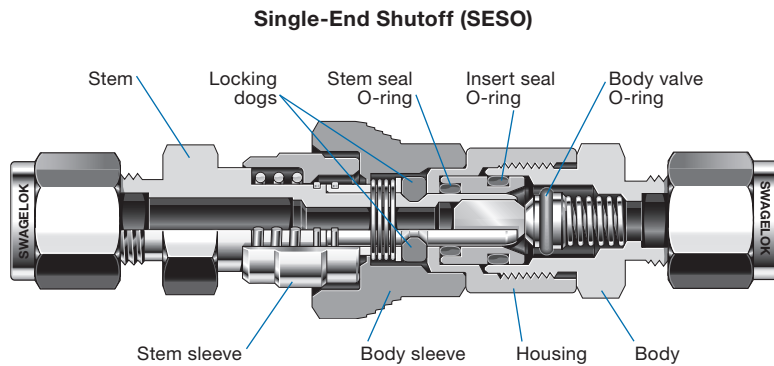

← Flow Direction →

Double-End Shutoff (DESO)—Red Stem Sleeve

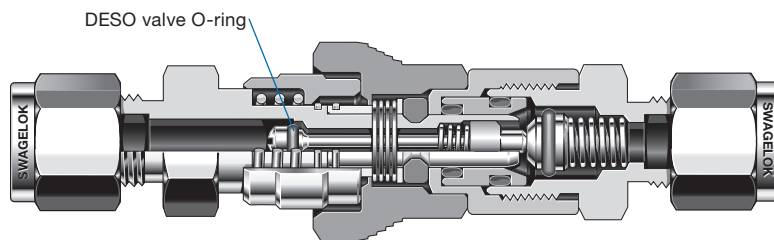

Materials of Construction

Component	Material	
	316 SS	Brass
<i>Body, stem, body valve, body insert</i>	316 SS	Brass C36000
<i>DESO valve, DESO retainer</i>	316 SS	QC4: 316 SS QC6/QC8: Brass C36000
<i>SES stem insert</i>	316 SS	Brass C26000
<i>O-rings</i>	Fluorocarbon FKM, ethylene propylene, perfluorocarbon FFKM	Buna N
<i>Springs</i>	316 SS	
<i>Snap rings</i>	302 SS	
<i>Body sleeve</i>	Powdered metal 300 series SS	Brass C36000
<i>Housing</i>	316 SS	Brass C36000
<i>DESO stem sleeve</i>	Polyurethane enamel-coated 316 SS	Polyurethane enamel-coated brass C36000
<i>SES stem sleeve</i>	316 SS	Brass C36000
<i>Locking dogs</i>	Xylan®-coated 316 SS powdered metal	
<i>Lubricants</i>	Silicone-based	
<i>Lubricants</i>	PTFE-based	

Wetted components listed in *italics*.

Other O-ring materials and lubricants available. Contact your authorized Swagelok sales and service representative.

Spillage and Air Inclusion

at 70°F (20°C)
Standard DESO and Body

Series	Spillage cm ³	Air Inclusion cm ³
QC4	0.3	0.3
QC6	1.0	1.0
QC8	3.0	3.0

Maximum Flow Rate

at 70°F (20°C)
SES and Full Flow Body

Series	Water Flow U.S. gal/min (L/min)
QC4	4 (15)
QC6	6 (22)
QC8	10 (37)

Pressure-Temperature Ratings, QC Series

QC4 Series

Material	316 SS			Brass
O-Ring Material	Fluoro-carbon FKM	Ethylene propylene	Perfluoro-carbon FFKM ^{①②}	Buna N
Temperature °F (°C)	Pressure Rating psig (bar)			
Coupled				
-50 (-45)	—	3000 (206)	—	—
0 (-17)	—	3000 (206)	—	2000 (137)
10 (-12)	3000 (206)	3000 (206)	—	2000 (137)
60 (15)	3000 (206)	3000 (206)	3000 (206)	2000 (137)
100 (37)	3000 (206)	3000 (206)	3000 (206)	2000 (137)
150 (65)	2750 (189)	2750 (189)	2750 (189)	1300 (89.5)
200 (93)	2300 (158)	2300 (158)	2300 (158)	700 (48.0)
250 (121)	1850 (127)	1850 (127)	1850 (127)	300 (20.6)
300 (148)	1400 (96.4)	1400 (96.4)	1400 (96.4)	—
350 (176)	950 (65.4)	—	950 (65.4)	—
400 (204)	500 (34.4)	—	500 (34.1) ^①	—
500 (260)	—	—	150 (10.3) ^②	—
Uncoupled and When Coupling and Uncoupling				
70 (20)	250 (17.2)			

① With KR designator (silicone-based lubricant).

② With KZ designator (PTFE-based lubricant).

QC6 Series

Material	316 SS			Brass
O-Ring Material	Fluoro-carbon FKM	Ethylene propylene	Perfluoro-carbon FFKM ^{①②}	Buna N
Temperature °F (°C)	Pressure Rating psig (bar)			
Coupled				
-50 (-45)	—	1500 (103)	—	—
0 (-17)	—	1500 (103)	—	1000 (68.9)
10 (-12)	1500 (103)	1500 (103)	—	1000 (68.9)
60 (15)	1500 (103)	1500 (103)	1500 (103)	1000 (68.9)
100 (37)	1500 (103)	1500 (103)	1500 (103)	1000 (68.9)
150 (65)	1350 (93.0)	1350 (93.0)	1350 (93.0)	700 (48.2)
200 (93)	1150 (79.2)	1150 (79.2)	1150 (79.2)	450 (31.0)
250 (121)	970 (66.8)	970 (66.8)	970 (66.8)	300 (20.6)
300 (148)	750 (51.6)	750 (51.6)	750 (51.6)	—
350 (176)	580 (39.9)	—	580 (39.9)	—
400 (204)	400 (27.5)	—	400 (27.5) ^①	—
500 (260)	—	—	150 (10.3) ^②	—
Uncoupled and When Coupling and Uncoupling				
70 (20)	250 (17.2)			

① With KR designator (silicone-based lubricant).

② With KZ designator (PTFE-based lubricant).

QC8 Series

Material	316 SS			Brass
O-Ring Material	Fluoro-carbon FKM	Ethylene propylene	Perfluoro-carbon FFKM ^{①②}	Buna N
Temperature °F (°C)	Pressure Rating psig (bar)			
Coupled				
-50 (-45)	—	750 (51.6)	—	—
0 (-17)	—	750 (51.6)	—	500 (34.4)
10 (-12)	750 (51.6)	750 (51.6)	—	500 (34.4)
60 (15)	750 (51.6)	750 (51.6)	750 (51.6)	500 (34.4)
100 (37)	750 (51.6)	750 (51.6)	750 (51.6)	500 (34.4)
150 (65)	680 (46.8)	680 (46.8)	680 (46.8)	400 (27.5)
200 (93)	600 (41.3)	600 (41.3)	600 (41.3)	350 (24.1)
250 (121)	520 (35.8)	520 (35.8)	520 (35.8)	300 (20.6)
300 (148)	440 (30.3)	440 (30.3)	440 (30.3)	—
350 (176)	360 (24.8)	—	360 (24.8)	—
400 (204)	300 (20.6)	—	300 (20.6) ^①	—
500 (260)	—	—	150 (10.3) ^②	—
Uncoupled and When Coupling and Uncoupling				
70 (20)	250 (17.2)			

① With KR designator (silicone-based lubricant).

② With KZ designator (PTFE-based lubricant).

Ordering Information and Dimensions, QC Series

Dimensions are for reference only and are subject to change.

Select a basic ordering number and add a material designator.

Fluorocarbon FKM O-rings are standard for 316 SS bodies and DESO stems; for other materials, add an O-ring material designator to the ordering number.

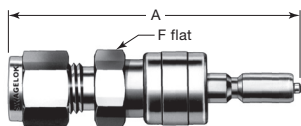

Material	Designator
316 SS	SS
Brass	B

Example: **SS-QC4-S-200**

O-Ring Material	Designator
Ethylene propylene	EP
Perfluorocarbon FFKM with silicone-based lubricant	KR
Perfluorocarbon FFKM with PTFE-based lubricant	KZ

Example **SS-QC4-B-200EP**

Stems

Swagelok Tube Fitting



Fitting Size	Basic Ordering Numbers		Series	Flow Coefficient (C _v)			Dimensions		
	SESO	DESO		SESO	DESO	Full Flow	A		F, in.
							SESO	DESO	
Dimensions, in. (mm)									
1/8	-QC4-S-200	-QC4-D-200 ^①	QC4	0.08	0.08	0.08	2.32 (58.9)	2.77 (70.4)	5/8 ^①
1/4	-QC4-S-400	-QC4-D-400	QC4	0.3	0.2	0.4	2.36 (59.9)	2.42 (61.5)	5/8
3/8	-QC6-S-600	-QC6-D-600	QC6	1.0	0.5	1.5	2.52 (64.0)	2.64 (67.1)	3/4
1/2	-QC8-S-810	-QC8-D-810	QC8	2.4	1.5	3.3	2.96 (75.2)	3.16 (80.3)	15/16
Dimensions, mm (in.)									
6	-QC4-S-6M0	-QC4-D-6M0	QC4	0.3	0.2	0.4	59.9 (2.36)	61.5 (2.42)	5/8
10	-QC6-S-10M0	-QC6-D-10M0	QC6	1.0	0.5	1.5	67.3 (2.65)	70.4 (2.77)	3/4
12	-QC8-S-12M0	-QC8-D-12M0	QC8	2.4	1.5	3.3	75.2 (2.96)	80.3 (3.16)	15/16

Dimensions shown with Swagelok tube fitting nuts finger-tight.

^① -QC4-D-200 is a two-piece assembly.

Male Pipe Threads



Pipe Size in.	Basic Ordering Numbers		Series	Flow Coefficient (C _v)			Dimensions, in. (mm)		
	SESO	DESO		SESO	DESO	Full Flow	A		F
							SESO	DESO	
NPT									
1/8	-QC4-S-2PM	-QC4-D-2PM	QC4	0.3	0.2	0.4	2.07 (52.6)	2.13 (54.1)	5/8
1/4	-QC4-S-4PM	-QC4-D-4PM	QC4	0.3	0.2	0.4	2.22 (56.4)	2.28 (57.9)	5/8
	-QC6-S-4PM	-QC6-D-4PM	QC6	0.9	0.5	1.5	2.32 (58.9)	2.44 (61.9)	3/4
3/8	-QC6-S-6PM	-QC6-D-6PM	QC6	0.8	0.5	1.6	2.35 (59.7)	2.47 (62.7)	3/4
1/2	-QC8-S-8PM	-QC8-D-8PM	QC8	2.0	1.3	3.1	2.84 (72.1)	3.04 (77.2)	15/16
ISO/BSP Tapered									
1/4	-QC4-S-4MT	-QC4-D-4MT	QC4	0.3	0.2	0.4	2.22 (56.4)	2.28 (57.9)	5/8
3/8	-QC6-S-6MT	-QC6-D-6MT	QC6	0.8	0.5	1.6	2.35 (59.7)	2.47 (62.7)	3/4
1/2	-QC8-S-8MT	-QC8-D-8MT	QC8	2.0	1.3	3.1	2.84 (72.1)	3.04 (77.2)	15/16

Female Pipe Threads



Pipe Size in.	Basic Ordering Numbers		Series	Flow Coefficient (C _v)			Dimensions, in. (mm)		
	SESO	DESO		SESO	DESO	Full Flow	A		F
							SESO	DESO	
NPT									
1/8	-QC4-S-2PF	-QC4-D-2PF	QC4	0.3	0.2	0.4	2.01 (51.1)	2.07 (52.6)	5/8
1/4	-QC4-S-4PF	-QC4-D-4PF	QC4	0.3	0.2	0.4	2.26 (57.4)	2.32 (58.9)	3/4
	-QC6-S-4PF	-QC6-D-4PF	QC6	0.9	0.5	1.5	2.35 (59.7)	2.47 (62.7)	3/4
3/8	-QC6-S-6PF	-QC6-D-6PF	QC6	0.8	0.5	1.6	2.35 (59.7)	2.47 (62.7)	7/8
1/2	-QC8-S-8PF	-QC8-D-8PF	QC8	2.0	1.3	3.1	2.82 (71.6)	3.02 (76.7)	1 1/16
ISO/BSP Tapered									
1/4	-QC4-S-4FT	-QC4-D-4FT	QC4	0.3	0.2	0.4	2.26 (57.4)	2.32 (58.9)	3/4
3/8	-QC6-S-6FT	-QC6-D-6FT	QC6	0.8	0.5	1.6	2.35 (59.7)	2.47 (62.7)	7/8
1/2	-QC8-S-8FT	-QC8-D-8FT	QC8	2.0	1.3	3.1	2.82 (71.6)	3.02 (76.7)	1 1/16

See next page for bodies.

Ordering Information and Dimensions, QC Series

Dimensions are for reference only and are subject to change.

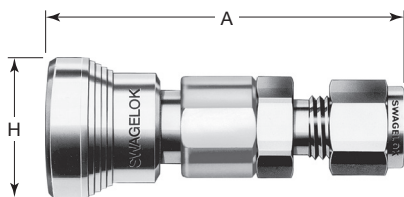

Bodies

Swagelok Tube Fitting

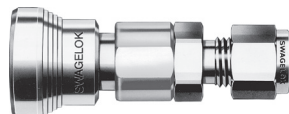

Fitting Size	Basic Ordering Number	Series	Dimensions	
			A	H
Dimensions, in. (mm)				
1/8	-QC4-B-200	QC4	2.26 (57.4)	0.91 (23.1)
1/4	-QC4-B-400	QC4	2.30 (58.4)	0.91 (23.1)
3/8	-QC6-B-600	QC6	2.58 (65.5)	1.03 (26.2)
1/2	-QC8-B-810	QC8	3.09 (78.5)	1.21 (30.7)
Dimensions, mm (in.)				
6	-QC4-B-6M0	QC4	58.4 (2.30)	23.1 (0.91)
10	-QC6-B-10M0	QC6	68.1 (2.68)	26.2 (1.03)
12	-QC8-B-12M0	QC8	78.5 (3.09)	30.7 (1.21)

Dimensions shown with Swagelok tube fitting nuts finger-tight.

Male Pipe Threads



Pipe Size in.	Basic Ordering Number	Series	Dimensions, in. (mm)	
			A	H
NPT				
1/8	-QC4-B-2PM	QC4	2.01 (51.1)	0.91 (23.1)
1/4	-QC4-B-4PM	QC4	2.16 (54.9)	0.91 (23.1)
	-QC6-B-4PM	QC6	2.38 (60.5)	1.03 (26.2)
3/8	-QC6-B-6PM	QC6	2.38 (60.5)	1.03 (26.2)
1/2	-QC8-B-8PM	QC8	2.97 (75.4)	1.21 (30.7)
ISO/BSP Tapered				
1/4	-QC4-B-4MT	QC4	2.16 (54.9)	0.91 (23.1)
3/8	-QC6-B-6MT	QC6	2.38 (60.5)	1.03 (26.2)
1/2	-QC8-B-8MT	QC8	2.97 (75.4)	1.21 (30.7)

Female Pipe Threads

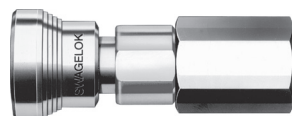

Pipe Size in.	Basic Ordering Number	Series	Dimensions, in. (mm)	
			A	H
NPT				
1/8	-QC4-B-2PF	QC4	2.16 (54.9)	0.91 (23.1)
1/4	-QC4-B-4PF	QC4	2.42 (61.5)	0.91 (23.1)
	-QC6-B-4PF	QC6	2.54 (64.5)	1.03 (26.2)
3/8	-QC6-B-6PF	QC6	2.57 (65.3)	1.03 (26.2)
1/2	-QC8-B-8PF	QC8	3.22 (81.8)	1.21 (30.7)
ISO/BSP Tapered				
1/4	-QC4-B-4FT	QC4	2.42 (61.5)	0.91 (23.1)
3/8	-QC6-B-6FT	QC6	2.57 (65.3)	1.03 (26.2)
1/2	-QC8-B-8FT	QC8	3.22 (81.8)	1.21 (30.7)

Insertion Depth

To calculate overall length in the coupled position, subtract the insertion depth from any overall stem and body combination length.

Series	Depth, in. (mm)	
	SESO	DESO
QC4	1.09 (27.7)	1.15 (29.2)
QC6	1.18 (30.0)	1.30 (33.0)
QC8	1.48 (37.6)	1.68 (42.7)

Full-Flow Quick-Connects

A full-flow QC series quick-connect consists of a SESO stem and a full-flow body.

To order a SESO stem, select a basic ordering number and add a material designator.

Example: **SS-QC4-S-200**

To order a full-flow body, select a basic ordering number and add a material designator and **MB**.

Example: **SS-QC4-B-200MB**

Ordering Information and Dimensions, QC Series

Dimensions are for reference only and are subject to change.

Bulkhead Stems

Swagelok Tube Fitting

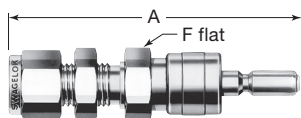

Fitting Size	Basic Ordering Numbers		Series	Dimensions				
	SESO	DESO		A		F	Max Panel Thickness	Min Panel Hole Dia
				SESO	DESO			
Dimensions, in. (mm)								
1/4	-QC4-S1-400	-QC4-D1-400	QC4	2.74 (69.6)	2.80 (71.1)	5/8	0.25 (6.4)	15/32 (11.9)
3/8	-QC6-S1-600	-QC6-D1-600	QC6	2.92 (74.2)	3.07 (78.0)	3/4	0.27 (6.9)	19/32 (15.1)
1/2	-QC8-S1-810	-QC8-D1-810	QC8	3.43 (87.1)	3.63 (92.2)	15/16	0.26 (6.6)	25/32 (19.8)
Dimensions, mm (in.)								
6	-QC4-S1-6M0	-QC4-D1-6M0	QC4	69.6 (2.74)	71.1 (2.80)	16	6.4 (0.25)	11.5 (29/64)
10	-QC6-S1-10M0	-QC6-D1-10M0	QC6	77.7 (3.06)	78.7 (3.10)	22	6.9 (0.27)	16.7 (21/32)
12	-QC8-S1-12M0	-QC8-D1-12M0	QC8	87.1 (3.43)	92.2 (3.63)	24	6.6 (0.26)	19.6 (49/64)

Dimensions shown with Swagelok tube fitting nuts finger-tight.

Bulkhead Bodies

Swagelok Tube Fitting

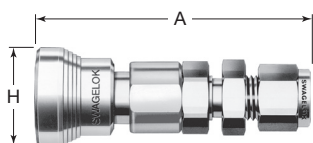

Fitting Size	Basic Ordering Number	Series	Dimensions			
			A	H	Max Panel Thickness	Min Panel Hole Dia
Dimensions, in. (mm)						
1/4	-QC4-B1-400	QC4	2.67 (67.8)	0.91 (23.1)	0.25 (6.4)	15/32 (11.9)
3/8	-QC6-B1-600	QC6	2.98 (75.7)	1.03 (26.2)	0.27 (6.9)	19/32 (15.1)
1/2	-QC8-B1-810	QC8	3.56 (90.4)	1.21 (30.7)	0.26 (6.6)	25/32 (19.8)
Dimensions, mm (in.)						
6	-QC4-B1-6M0	QC4	67.8 (2.67)	23.1 (0.91)	6.4 (0.25)	11.9 (15/32)
10	-QC6-B1-10M0	QC6	75.9 (2.99)	26.2 (1.03)	6.9 (0.27)	16.7 (21/32)
12	-QC8-B1-12M0	QC8	90.4 (3.56)	30.7 (1.21)	6.6 (0.26)	19.6 (49/64)

Dimensions shown with Swagelok tube fitting nuts finger-tight.

Options, QC Series

Stem and Body Protectors

Stem and body protectors guard against damage and contaminants when bodies and stems are uncoupled.

Protectors are not pressure-containing devices; for pressure-retaining protectors, contact your authorized Swagelok representative.

Materials

Component	Material
Protector	316 SS or plated brass C36000
Lanyard	302 SS
Lanyard clamps	304 SS

Ordering Information

To order, select a basic ordering number and add **SS** for stainless steel or **B** for brass.

Series	Basic Ordering Numbers	
	Stem Protector	Body Protector
QC4	-QC4-SP	-QC4-BP
QC6	-QC6-SP	-QC6-BP
QC8	-QC8-SP	-QC8-BP

Example: **SS-QC4-SP**

Keyed Protectors

To order a keyed protector, add a key designator from the table on page 8 to the ordering number.

Example: **SS-QC4-SPK1**

Stem Protectors

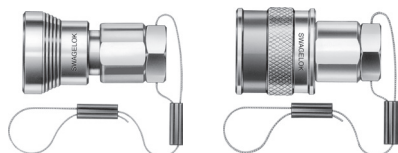

Standard

Keyed

Body Protectors

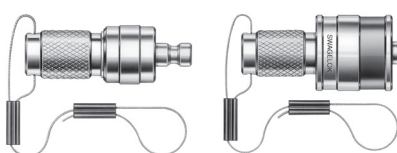

Standard

Keyed

Options, QC Series

Keyed QC Series

Swagelok keyed quick-connects provide a positive mechanical lockout system to prevent accidental intermixing of different lines in multifluid or multipressure systems.

Features

- Keyed quick-connects will not interchange with any other Swagelok keyed quick-connects
- If an attempt is made to couple unlike keys, the valve system will not open.
- Stems and bodies are color coded and numbered for easy identification.

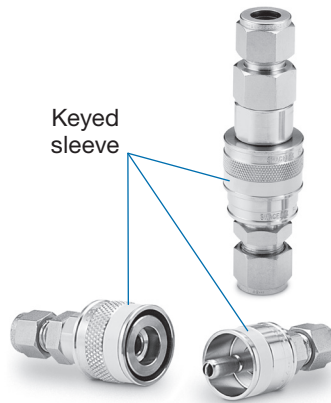

QC Series Key Numbers and Sleeve Outside Diameters

for use in calculating alignment positions when panel mounting

Key Color	Key Number and Designator	Sleeve Outside Diameter, in. (mm)					
		QC4		QC6		QC8	
		Body	Stem	Body	Stem	Body	Stem
Black	K1	0.96 (24.4)	0.82 (20.8)	1.13 (28.7)	0.99 (25.1)	1.26 (32.0)	1.10 (27.9)
Orange	K2	0.99 (25.1)	0.85 (21.6)	1.16 (29.5)	1.02 (25.9)	1.29 (32.8)	1.14 (29.0)
Green	K3	1.02 (25.9)	0.88 (22.4)	1.19 (30.2)	1.05 (26.7)	1.32 (33.5)	1.17 (29.7)
Yellow	K4	1.05 (26.7)	0.91 (23.1)	1.22 (31.0)	1.08 (27.4)	1.35 (34.3)	1.20 (30.5)
Blue	K5	1.08 (27.4)	0.94 (23.9)	1.24 (31.5)	1.11 (28.2)	1.38 (35.1)	1.23 (31.2)
White	K6	1.11 (28.2)	0.97 (24.6)	1.28 (32.5)	1.14 (29.0)	1.41 (35.8)	1.26 (32.0)
Purple	K7	1.14 (29.0)	1.00 (25.4)	1.31 (33.3)	1.17 (29.7)	1.44 (36.6)	1.29 (32.8)
Brown	K8	1.17 (29.7)	1.03 (26.2)	1.34 (34.0)	1.20 (30.5)	1.47 (37.3)	1.32 (33.5)

Ordering Information

To order, add a key number designator to a QC series quick-connect ordering number.

Example: SS-QC4-S-200K1

Bulkhead Bodies with Two Panel Nuts

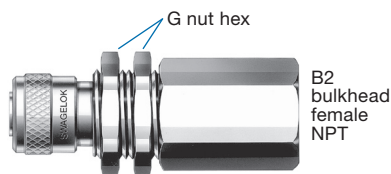

Dimensions

Series	G	Dimensions, in. (mm)	
		Max Panel Thickness	Min Panel Hole Dia
QC4	7/8	0.20 (5.1)	23/32 (18.3)
QC6	15/16	0.25 (6.4)	27/32 (21.4)
QC8	1 1/8	0.31 (7.9)	1 1/32 (26.2)

Ordering Information

To order, replace **B** in the ordering number with **B2**.

Example: SS-QC4-B2-400

B2 style bulkhead body is available only with low-profile IS sleeve.

Low-Profile Sleeve

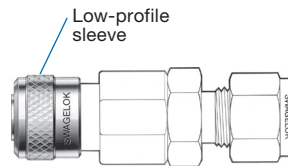

This option is available for use in areas where space is limited.

Ordering Information

To order, add **IS** to the ordering number.

Example: SS-QC4-B-400IS

Additional End Connections

Other end connections may be available from the factory as two-piece components. Contact your authorized Swagelok representative for information.

Full Flow Quick-Connects QF Series

Features

- Compact coupling offers full flow without orifice restrictions.
- O-ring is easily replaced without disassembling body.

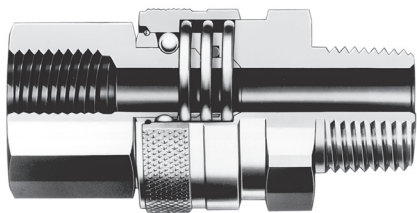

← Bidirectional flow →

⚠ **Warning: Do not uncouple under pressure.**

Pressure-Temperature Ratings, QF Series

Pressure ratings may be limited by end connections.

QF4 Series and QF8 Series

Material	316 SS			Brass	
	O-Ring Material	Fluoro-carbon FKM	Ethylene propylene	Perfluoro-carbon FFKM ^{①②}	Buna N
Series	QF4 and QF8			QF4	QF8
Temperature °F (°C)	Pressure Rating psig (bar)				
Coupled					
-50 (-45)	—	6000 (413)	—	—	—
0 (-17)	—	6000 (413)	—	4000 (275)	3000 (206)
10 (-12)	6000 (413)	6000 (413)	—	4000 (275)	3000 (206)
40 (4)	6000 (413)	6000 (413)	6000 (413)	4000 (275)	3000 (206)
100 (37)	6000 (413)	6000 (413)	6000 (413)	4000 (275)	3000 (206)
150 (65)	5000 (344)	4000 (275)	5000 (344)	2700 (186)	2000 (137)
200 (93)	4000 (275)	2700 (186)	4000 (275)	1400 (96.4)	1000 (68.9)
250 (121)	3000 (206)	1400 (96.4)	3000 (206)	300 (20.6)	300 (20.6)
300 (148)	2000 (137)	400 (27.5)	2000 (137)	—	—
350 (176)	1200 (82.6)	—	1200 (82.6)	—	—
400 (204)	400 (27.5)	—	400 ^① (27.5)	—	—
500 (260)	—	—	200 ^② (13.7)	—	—

① With KR designator (silicone-based lubricant).

② With KZ designator (PTFE-based lubricant).

Materials of Construction

Component	Material	
	316 SS	Brass
Body, stem	316 SS	Brass C36000
Spring, snap ring, locking balls	316 SS	
Sleeve	316 SS	Brass C36000
O-ring	Fluorocarbon FKM, ethylene propylene, perfluorocarbon FFKM	Buna N
Lubricants	Silicone-based	

Wetted components listed in *italics*.

Other O-ring materials and lubricants available. Contact your authorized Swagelok representative.

QF12 Series and QF16 Series

Material	316 SS			Brass	
	O-Ring Material	Fluoro-carbon FKM	Ethylene propylene	Perfluoro-carbon FFKM ^{①②}	Buna N
Temperature °F (°C)	Pressure Rating psig (bar)				
	Coupled				
-50 (-45)	—	4000 (275)	—	—	—
0 (-17)	—	4000 (275)	—	—	2000 (137)
10 (-12)	4000 (275)	4000 (275)	—	—	2000 (137)
40 (4)	4000 (275)	4000 (275)	4000 (275)	—	2000 (137)
100 (37)	4000 (275)	4000 (275)	4000 (275)	—	2000 (137)
150 (65)	3500 (241)	2000 (137)	3500 (241)	—	1300 (89.5)
200 (93)	2800 (192)	1300 (89.5)	2800 (192)	—	700 (48.2)
250 (121)	2100 (144)	700 (48.2)	2100 (144)	—	200 (13.7)
300 (148)	1400 (96.4)	200 (13.7)	1400 (96.4)	—	—
350 (176)	800 (55.1)	—	800 (55.1)	—	—
400 (204)	200 (13.7)	—	200 (13.7) ^①	—	—
500 (260)	—	—	150 (10.3) ^②	—	—

① With KR designator (silicone-based lubricant).

② With KZ designator (PTFE-based lubricant).

Ordering Information and Dimensions, QF Series

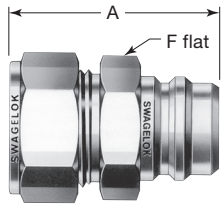

Dimensions are for reference only and are subject to change.

Select a basic ordering number and add a material designator.

Material	Designator
316 SS	SS
Brass	B

Example: **SS-QF4-S-400**

Fluorocarbon FKM O-rings are standard for 316 SS bodies; for other materials, add an O-ring material designator to the ordering number.

O-Ring Material	Designator
Ethylene propylene	EP
Perfluorocarbon FFKM with silicone-based lubricant	KR
Perfluorocarbon FFKM with PTFE-based lubricant	KZ

Example **SS-QF4-B-400EP**

Stems

Swagelok Tube Fitting



Fitting Size	Basic Ordering Number	Series	Flow Coefficient (C _v)	Dimensions		
				A	F in.	Min Orifice
Dimensions, in. (mm)						
1/4	-QF4-S-400	QF4	2.2	1.77 (45.0)	9/16	0.19 (4.8)
3/8	-QF4-S-600	QF4	2.8	1.77 (45.0)	11/16	0.24 (6.1)
	-QF8-S-600	QF8	2.9	1.88 (47.8)	7/8	0.28 (7.1)
1/2	-QF8-S-810	QF8	13.0	1.99 (50.5)	7/8	0.41 (10.4)
3/4	-QF12-S-1210	QF12	26.0	2.15 (54.6)	1 1/16	0.62 (15.7)
1	-QF16-S-1610	QF16	45.0	2.45 (62.2)	1 3/8	0.88 (22.4)
Dimensions, mm (in.)						
6	-QF4-S-6M0	QF4	2.2	45.0 (1.77)	9/16	4.8 (0.19)

Dimensions shown with Swagelok tube fitting nuts finger-tight.

Female Pipe Threads



Pipe Size in.	Basic Ordering Number	Series	Flow Coefficient (C _v)	Dimensions, in. (mm)		
				A	F	Min Orifice
NPT						
1/4	-QF4-S-4PF	QF4	1.7	1.60 (40.6)	3/4	0.24 (6.1)
3/8	-QF4-S-6PF	QF4	1.7	1.67 (42.4)	7/8	0.24 (6.1)
	-QF8-S-6PF	QF8	7.1	1.59 (40.4)	1 1/16	0.47 (11.9)
1/2	-QF8-S-8PF	QF8	11.5	1.82 (46.2)	1 1/16	0.50 (12.7)
3/4	-QF12-S-12PF	QF12	23.6	2.08 (52.8)	1 5/16	0.72 (18.3)
1	-QF16-S-16PF	QF16	39.0	2.49 (63.2)	1 5/8	0.88 (22.4)
ISO/BSP Tapered						
1/4	-QF4-S-4FT	QF4	1.7	1.60 (40.6)	3/4	0.24 (6.1)
1/2	-QF8-S-8FT	QF8	11.5	1.82 (46.2)	1 1/16	0.50 (12.7)
ISO/BSP Parallel						
1/4	-QF4-S-4FS	QF4	1.7	1.60 (40.6)	3/4	0.24 (6.1)
1/2	-QF8-S-8FS	QF8	11.5	1.82 (46.2)	1 1/16	0.50 (12.7)

Ordering Information and Dimensions, QF Series

Dimensions are for reference only and are subject to change.

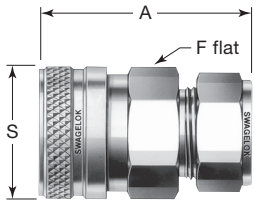

Insertion Depth

To calculate overall length in the coupled position, subtract the insertion depth from any overall stem and body combination length.

Series	Depth in. (mm)
QF4	0.78 (19.8)
QF8	0.81 (20.6)
QF12	0.90 (22.9)
QF16	0.94 (23.9)

Bodies

Swagelok Tube Fitting



Fitting Size	Basic Ordering Number	Series	Dimensions			
			A	F in.	S	Min Orifice
Dimensions, in. (mm)						
1/4	-QF4-B-400	QF4	1.80 (45.7)	11/16	0.87 (22.1)	0.19 (4.8)
3/8	-QF4-B-600	QF4	1.81 (46.0)	11/16	0.87 (22.1)	0.28 (7.1)
	-QF8-B-600	QF8	2.17 (55.1)	1 1/16	1.30 (33.0)	
1/2	-QF8-B-810	QF8	2.23 (56.6)	1 1/16	1.30 (33.0)	0.47 (11.9)
3/4	-QF12-B-1210	QF12	2.45 (62.2)	1 1/2	1.66 (42.2)	0.62 (15.7)
1	-QF16-B-1610	QF16	2.75 (69.9)	1 11/16	1.88 (47.8)	0.88 (22.4)
Dimensions, mm (in.)						
6	-QF4-B-6M0	QF4	45.7 (1.80)	11/16	22.1 (0.87)	4.8 (0.19)

Dimensions shown with Swagelok tube fitting nuts finger-tight.

Female Pipe Threads



Pipe Size in.	Basic Ordering Number	Series	Dimensions, in. (mm)			
			A	F	S	Min Orifice
NPT						
1/4	-QF4-B-4PF	QF4	1.50 (38.1)	3/4	0.87 (22.1)	0.38 (9.7)
3/8	-QF4-B-6PF	QF4	1.63 (41.4)	7/8	0.87 (22.1)	0.38 (9.7)
	-QF8-B-6PF	QF8	1.73 (43.9)	1 1/16	1.30 (33.0)	0.59 (15.0)
1/2	-QF8-B-8PF	QF8	1.73 (43.9)	1 1/16	1.30 (33.0)	0.63 (16.0)
3/4	-QF12-B-12PF	QF12	1.89 (48.0)	1 1/2	1.66 (42.2)	0.88 (22.4)
1	-QF16-B-16PF	QF16	2.12 (53.8)	1 11/16	1.88 (47.8)	1.06 (26.9)
ISO/BSP Tapered						
1/4	-QF4-B-4FT	QF4	1.50 (38.1)	3/4	0.87 (22.1)	0.38 (9.7)
1/2	-QF8-B-8FT	QF8	1.73 (43.9)	1 1/16	1.30 (33.0)	0.63 (16.0)
ISO/BSP Parallel						
1/4	-QF4-B-4FS	QF4	1.50 (38.1)	3/4	0.87 (22.1)	0.38 (9.7)
1/2	-QF8-B-8FS	QF8	1.73 (43.9)	1 1/16	1.30 (33.0)	0.63 (16.0)

Ordering Information and Dimensions, QF Series

Dimensions are for reference only and are subject to change.

Stems

Male Pipe Threads



Pipe Size in.	Basic Ordering Number	Series	Flow Coefficient (C _v)	Dimensions, in. (mm)		
				A	F	Min Orifice
NPT						
1/4	-QF4-S-4PM	QF4	1.7	1.59 (40.4)	9/16	0.24 (6.1)
3/8	-QF4-S-6PM	QF4	1.7	1.59 (40.4)	11/16	0.24 (6.1)
	-QF8-S-6PM	QF8	7.1	1.65 (41.9)	7/8	0.41 (10.4)
1/2	-QF8-S-8PM	QF8	11.5	1.84 (46.7)	7/8	0.50 (12.7)
3/4	-QF12-S-12PM	QF12	23.6	2.03 (51.6)	1 1/16	0.72 (18.3)
1	-QF16-S-16PM	QF16	39.0	2.35 (59.7)	1 3/8	0.88 (22.4)
ISO/BSP Tapered						
1/4	-QF4-S-4MT	QF4	1.7	1.59 (40.4)	9/16	0.24 (6.1)
1/2	-QF8-S-8MT	QF8	11.5	1.84 (46.7)	7/8	0.50 (12.7)
1	-QF16-S-16MT	QF16	39.0	2.35 (59.7)	1 3/8	0.88 (22.4)
ISO/BSP Parallel^①						
1/4	-QF4-S-4MS	QF4	1.7	1.60 (40.6)	3/4	0.24 (6.1)
1/2	-QF8-S-8MS	QF8	11.5	1.82 (46.2)	1 1/16	0.50 (12.7)

① Include a female 60° cone profile. They accept a 60° male cone with female swivel nut.

Bodies

Male Pipe Threads



Pipe Size in.	Basic Ordering Number	Series	Dimensions, in. (mm)			
			A	F	S	Min Orifice
NPT						
1/4	-QF4-B-4PM	QF4	1.57 (39.9)	11/16	0.87 (22.1)	0.25 (6.4)
3/8	-QF4-B-6PM	QF4	1.57 (39.9)	11/16	0.87 (22.1)	0.37 (9.4)
	-QF8-B-6PM	QF8	1.83 (46.5)	1 1/16	1.30 (33.0)	0.41 (10.4)
1/2	-QF8-B-8PM	QF8	2.08 (52.8)	1 1/16	1.30 (33.0)	0.50 (12.7)
3/4	-QF12-B-12PM	QF12	2.33 (59.2)	1 1/2	1.66 (42.2)	0.72 (18.3)
1	-QF16-B-16PM	QF16	2.65 (67.3)	1 11/16	1.88 (47.8)	0.88 (22.4)
ISO/BSP Tapered						
1/4	-QF4-B-4MT	QF4	1.57 (39.9)	11/16	0.87 (22.1)	0.24 (6.1)
1/2	-QF8-B-8MT	QF8	2.08 (52.8)	1 1/16	1.30 (33.0)	0.50 (12.7)
1	-QF16-B-16MT	QF16	2.65 (67.3)	1 11/16	1.88 (47.8)	0.88 (22.4)
ISO/BSP Parallel^①						
1/4	-QF4-B-4MS	QF4	1.80 (45.7)	3/4	0.87 (22.1)	0.24 (6.1)
1/2	-QF8-B-8MS	QF8	2.08 (52.8)	1 1/16	1.30 (33.0)	0.47 (11.9)

① Include a female 60° cone profile. They accept a 60° male cone with female swivel nut.

Options, QF Series

Stem and Body Protectors

Stem and body protectors guard against damage and contaminants when bodies and stems are uncoupled.

Protectors are not pressure-containing devices; for pressure-retaining protectors, contact your authorized Swagelok representative.

Materials

Component	Material
Protector	316 SS or plated brass C36000
Lanyard	302 SS
Lanyard clamps	304 SS

Stem Protector



Body Protector

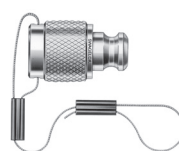

Ordering Information

To order, select a basic ordering number and add **SS** for stainless steel or **B** for brass.

Series	Basic Ordering Number	
	Stem Protector	Body Protector
QF4	-QF4-SP	-QF4-BP
QF8	-QF8-SP	-QF8-BP
QF12	-QF12-SP	-QF12-BP
QF16	-QF16-SP	-QF16-BP

Example: **SS-QF4-SP**

Miniature Quick-Connects QM Series

Features

- Lightweight, compact design offers fingertip operation.
- Low dead volume reduces spillage and air inclusion.

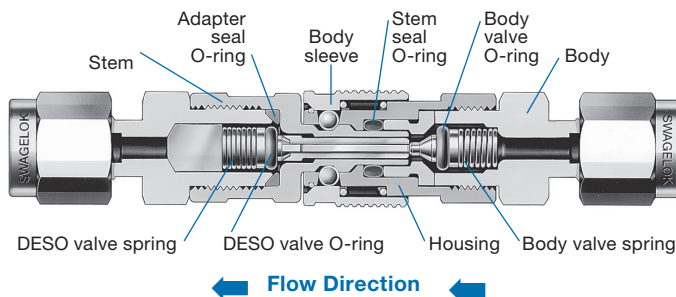

Materials of Construction

Component	Material	
	316 SS	Brass
<i>Body, body insert, SESO stem insert, DESO adapter, stem</i>	316 SS	Brass C36000
<i>Body valve, valve stop, DESO valve, DESO stem fin, springs</i>	316 SS	
<i>O-rings</i>	<i>Fluorocarbon FKM, ethylene propylene, perfluorocarbon FFKM</i>	<i>Buna N</i>
Sleeve, housing	316 SS	Brass C36000
Locking balls, snap rings	316 SS	
Lubricants	Silicone-based	
Lubricants	PTFE-based	

Wetted components listed in *italics*.

Other O-ring materials and lubricants available. Contact your authorized Swagelok representative.

Pressure-Temperature Ratings

Material	316 SS			Brass
	O-Ring Material	Fluoro-carbon FKM	Ethylene propylene	Perfluoro-carbon FFKM ^{①②} Buna N
Temperature °F (°C)	Pressure Rating psig (bar)			
Coupled				
-50 (-45)	—	4000 (275)	—	—
0 (-17)	—	4000 (275)	—	2000 (137)
10 (-12)	4000 (275)	4000 (275)	—	2000 (137)
40 (4)	4000 (275)	4000 (275)	4000 (275)	2000 (137)
100 (37)	4000 (275)	4000 (275)	4000 (275)	2000 (137)
150 (65)	3500 (241)	3500 (241)	3500 (241)	1300 (89.5)
200 (93)	2800 (192)	2800 (192)	2800 (192)	700 (48.0)
250 (121)	2100 (144)	2100 (144)	2100 (144)	200 (13.7)
300 (148)	1400 (96.4)	1400 (96.4)	1400 (96.4)	—
350 (176)	800 (55.1)	—	800 (55.1)	—
400 (204)	200 (13.7)	—	200 (13.7) ^①	—
500 (260)	—	—	150 (10.3) ^②	—
Uncoupled and When Coupling and Uncoupling				
70 (20)	100 (6.8)			

① With KR designator (silicone-based lubricant).

② With KZ designator (PTFE-based lubricant).

Spillage and Air Inclusion

0.1 cm³

(Standard DESO and Body)

Maximum Flow Rate

1 U.S. gal/min (3.8 L/min)
water at 70°F (20°C)

(SESO and Full Flow Body)

Ordering Information and Dimensions, QM Series

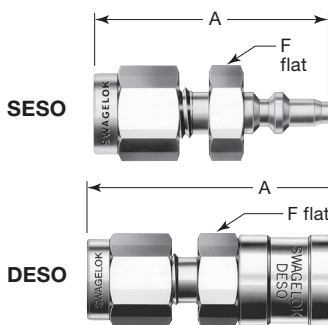

Dimensions are for reference only and are subject to change.

Select a basic ordering number and add a material designator.

Material	Designator
316 SS	SS
Brass	B

Example: **SS-QM2-S-100**

Fluorocarbon FKM O-rings are standard for 316 SS bodies and DESO stems; for other materials, add an O-ring material designator to the ordering number.

O-Ring Material	Designator
Ethylene propylene	EP
Perfluorocarbon FFKM with silicone-based lubricant	KR
Perfluorocarbon FFKM with PTFE-based lubricant	KZ

Example **SS-QM2-B-100EP**

Stems

Swagelok Tube Fitting



Fitting Size in.	Basic Ordering Numbers		Series	Flow Coefficient (C _v)			Dimensions, in. (mm)		
	SESO	DESO		SESO	DESO	Full Flow	A		F
							SESO	DESO	
1/16	-QM2-S-100	-QM2-D-100	QM2	0.06	0.05	0.06	1.18 (30.0)	1.76 (44.7)	7/16
1/8	-QM2-S-200	-QM2-D-200					1.29 (32.8)	1.87 (47.5)	

Dimensions shown with Swagelok tube fitting nuts finger-tight.

Ordering Information and Dimensions, QM Series

Dimensions are for reference only and are subject to change.

Stems

Male NPT



NPT Size in.	Basic Ordering Numbers		Series	Flow Coefficient (C _v)			Dimensions, in. (mm)		
	SESO	DESO		SESO	DESO	Full Flow	A		F
							SESO	DESO	
1/16 1/8	-QM2-S-1PM -QM2-S-2PM	-QM2-D-1PM -QM2-D-2PM	QM2	0.06	0.05	0.06	1.03 (26.2)	1.61 (40.9)	7/16

Female NPT

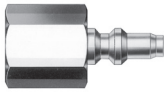

NPT Size in.	Basic Ordering Numbers		Series	Flow Coefficient (C _v)			Dimensions, in. (mm)		
	SESO	DESO		SESO	DESO	Full Flow	A		F
							SESO	DESO	
1/16 1/8	-QM2-S-1PF -QM2-S-2PF	-QM2-D-1PF -QM2-D-2PF	QM2	0.06	0.05	0.06	1.03 (26.2) 1.18 (30.0)	1.61 (40.9) 1.81 (46.0)	7/16 9/16

Bodies

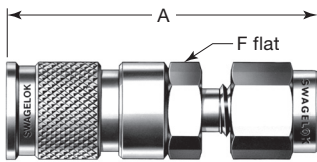

Swagelok Tube Fitting



Fitting Size in.	Basic Ordering Number	Series	Dimensions, in. (mm)	
			A	F
1/16 1/8	-QM2-B-100 -QM2-B-200	QM2	1.50 (38.1) 1.70 (43.2)	7/16

Dimensions shown with Swagelok tube fitting nuts finger-tight.

Male NPT



NPT Size in.	Basic Ordering Number	Series	Dimensions, in. (mm)	
			A	F
1/16 1/8	-QM2-B-1PM -QM2-B-2PM	QM2	1.42 (36.1) 1.44 (36.6)	7/16

Female NPT



NPT Size in.	Basic Ordering Number	Series	Dimensions, in. (mm)	
			A	F
1/16 1/8	-QM2-B-1PF -QM2-B-2PF	QM2	1.43 (36.3) 1.62 (41.1)	7/16 9/16

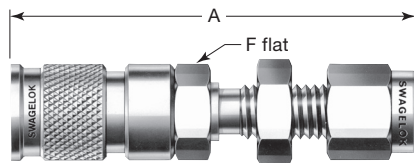

Swagelok Bulkhead Tube Fitting

Fitting Size in.	Basic Ordering Number	Series	Dimensions, in. (mm)	
			A	F
1/8	-QM2-B1-200	QM2	2.09 (53.1)	7/16

Dimensions shown with Swagelok tube fitting nuts finger-tight. Maximum panel thickness is 0.25 in. (6.4 mm); minimum panel hole diameter is 21/64 in. (8.3 mm).

Insertion Depth

To calculate overall length in the coupled position, subtract the insertion depth from any overall stem and body combination length.

Depth, in. (mm)	
SESO	DESO
0.47 (11.9)	0.53 (13.5)

Full-Flow Quick-Connects

A full-flow QM series quick-connect consists of a SESO stem and a full-flow body.

To order a SESO stem, select a basic ordering number and add a material designator.

Example: **SS-QM2-S-200**

To order a full-flow body, select a basic ordering number and add a material designator and **MB**.

Example: **SS-QM2-B-200MB**

PTFE-Sealed Quick-Connects QTM Series

Features

- Product qualification tests are based on ANSI B93.51M.
- Flush valve design reduces air inclusion and spillage.
- Locking dog mechanism with large contact area retains stem.
- Seals are recessed for protection.
- Keyed option is available.
- Push-to-connect design enables quick, simple operation.

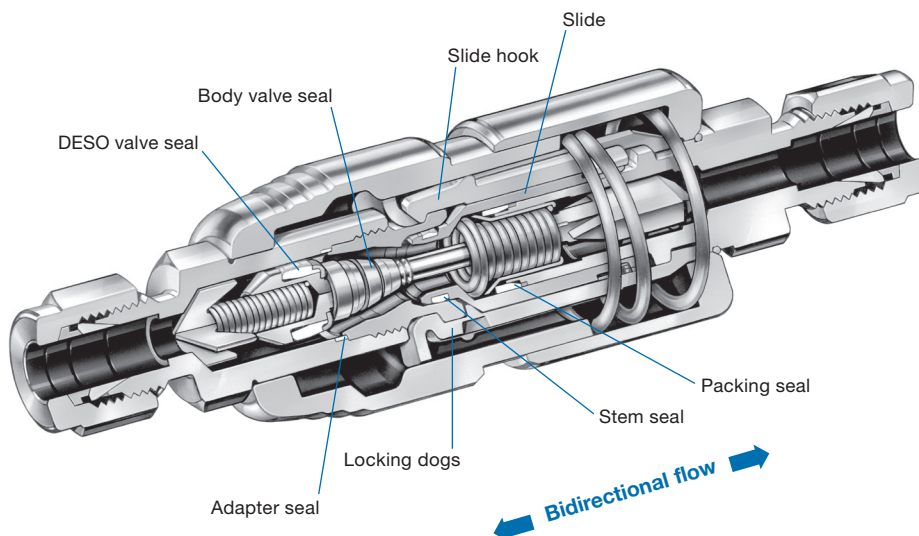

Materials of Construction

Component	Material	
	316 SS	Alloy 400
Body	<i>Xylan-coated</i> 316 SS	<i>Xylan-coated</i> alloy 400
<i>Slide, stem, stem adapter, body valve, DESO valve, packing gland, body bolt, body valve seal cap, DESO valve seal cap, DESO stem fins</i>	316 SS	Alloy 400
<i>Eyelet, body insert, DESO valve post</i>	316 SS	—
Snap rings	316 SS	Alloy X-750
<i>Body fin (QTM4 only)</i>	<i>PTFE-coated powdered metal</i> 300 series SS	—
<i>Front ferrule (QTM4 only)</i>	316 SS	—
Springs	316 SS and Elgiloy®	Alloy X-750 and Elgiloy
<i>Packing seal, stem seal, adapter seal</i>	<i>Modified PTFE</i>	
<i>Body valve seal, DESO valve seal</i>	<i>Virgin PTFE</i>	
Packing backup ring	Filled PTFE	
Locking dogs	316 SS or CF8M	M-35-1
Rear sleeve, front sleeve, slide hooks	316 SS	Alloy 400
Lubricants	<i>Hydrocarbon-based</i>	
Lubricants	<i>PTFE-based</i>	

Wetted components listed in *italics*.

Pressure-Temperature Ratings

Pressure ratings may be limited by end connections.

Temperature °F (°C)	316 SS			Alloy 400
	QTM2	QTM4	QTM8	QTM2
	Pressure Rating, psig (bar)			
Coupled				
0 to 120 (-17 to 48)	4500 (310)	3200 (220)		3200 (220)
120 to 350 (48 to 176)	800 (55.1)			
Uncoupled				
0 to 120 (-17 to 48)	1000 (68.9)		1000 (68.9)	
120 to 350 (48 to 176)	800 (55.1)			
When Coupling And Uncoupling				
70 (20)	250 (17.2)	100 (6.8)	50 (3.4)	250 (17.2)

Maximum Flow Rate

at 70°F (20°C)

SESO and Full Flow Body

Series	Water Flow U.S. gal/min (L/min)
QTM2	15 (56)
QTM4	35 (130)
QTM8	50 (180)

Spillage and Air Inclusion

at 70°F (20°C)

Standard DESO and Body

Series	Spillage cm ³	Air Inclusion cm ³
QTM2	0.1	0.1
QTM4	0.2	0.4
QTM8	1.0	2.0

Ordering Information and Dimensions, QTM Series

Dimensions are for reference only and are subject to change.

Select an ordering number.

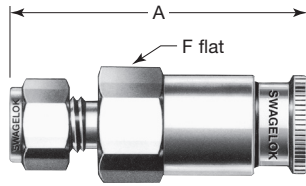

Stems

Swagelok Tube Fitting

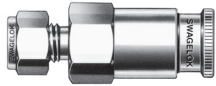

Fitting Size	Ordering Numbers		Series	Flow Coefficient (C _v)		Dimensions	
	SESO	DESO		SESO	DESO	A	F
Dimensions, in. (mm)							
1/4	SS-QTM2-S-400 ^①	SS-QTM2-D-400 ^①	QTM2	0.7	0.6	2.02 (51.3)	5/8
	SS-QTM4-S-400	SS-QTM4-D-400	QTM4	0.9	0.8	2.61 (66.3)	15/16
3/8	SS-QTM2-S-600	SS-QTM2-D-600	QTM2	0.9	0.8	2.08 (52.8)	11/16
	SS-QTM4-S-600	SS-QTM4-D-600	QTM4	1.7	1.6	2.67 (67.8)	15/16
1/2	SS-QTM8-S-810	SS-QTM8-D-810	QTM8	4.2	3.1	3.06 (77.7)	1 5/16
3/4	SS-QTM8-S-1210	SS-QTM8-D-1210	QTM8	6.7	6.5	3.06 (77.7)	1 5/16
1	SS-QTM8-S-1610	SS-QTM8-D-1610	QTM8	9.0	7.8	3.27 (83.1)	1 3/8
Dimensions, mm (in.)							
6	SS-QTM2-S-6M0 ^①	SS-QTM2-D-6M0 ^①	QTM2	0.7	0.6	51.3 (2.02)	16
	SS-QTM4-S-6M0	SS-QTM4-D-6M0	QTM4	0.9	0.8	66.3 (2.61)	24
8	SS-QTM2-S-8M0	SS-QTM2-D-8M0	QTM2	0.9	0.8	53.1 (2.09)	11/16 in.
10	SS-QTM4-S-10M0	SS-QTM4-D-10M0	QTM4	1.7	1.6	68.1 (2.68)	24
12	SS-QTM8-S-12M0	SS-QTM8-D-12M0	QTM8	4.2	3.1	77.7 (3.06)	35

Dimensions shown with Swagelok tube fitting nuts finger-tight.

^① To order alloy 400 with PTFE seals, replace **SS** in the ordering number with **M**.

Example: **M**-QTM2-S-400

Male Pipe Threads



Pipe Size in.	Ordering Numbers		Series	Flow Coefficient (C _v)		Dimensions in. (mm)	
	SESO	DESO		SESO	DESO	A	F
NPT							
1/4	SS-QTM2-S-4PM ^①	SS-QTM2-D-4PM ^①	QTM2	0.2	0.2	1.91 (48.5)	5/8
	SS-QTM4-S-4PM	SS-QTM4-D-4PM	QTM4	1.4	1.4	2.46 (62.5)	15/16
3/8	SS-QTM2-S-6PM	SS-QTM2-D-6PM	QTM2	0.7	0.6	2.04 (51.8)	3/4
	SS-QTM4-S-6PM	SS-QTM4-D-6PM	QTM4	1.8	1.7	2.46 (62.5)	15/16
1/2	SS-QTM8-S-8PM	SS-QTM8-D-8PM	QTM8	5.1	4.4	2.78 (70.6)	1 5/16
3/4	SS-QTM8-S-12PM	SS-QTM8-D-12PM	QTM8	8.5	7.8	2.78 (70.6)	1 5/16
1	SS-QTM8-S-16PM	SS-QTM8-D-16PM	QTM8	②	②	3.03 (77.0)	1 3/8
ISO/BSP Tapered							
1/4	SS-QTM2-S-4MT	SS-QTM2-D-4MT	QTM2	0.2	0.2	1.91 (48.5)	5/8
	SS-QTM4-S-4MT	SS-QTM4-D-4MT	QTM4	1.4	1.4	2.46 (62.5)	15/16
1/2	SS-QTM8-S-8MT	SS-QTM8-D-8MT	QTM8	5.1	4.4	2.78 (70.6)	1 5/16
ISO/BSP Parallel^③							
1/8	SS-QTM2-S-2MS	SS-QTM2-D-2MS	QTM2	0.5	0.4	1.73 (43.9)	5/8
1/4	SS-QTM2-S-4MS	SS-QTM2-D-4MS	QTM2	0.6	0.6	2.04 (51.8)	3/4
	SS-QTM4-S-4MS	SS-QTM4-D-4MS	QTM4	1.2	1.2	2.48 (63.0)	15/16
1/2	SS-QTM8-S-8MS	SS-QTM8-D-8MS	QTM8	4.8	3.9	2.78 (70.6)	1 5/16
JIC 37° Flare							
1/4	SS-QTM4-S-4AN	SS-QTM4-D-4AN	QTM4	②	②	2.48 (63.0)	15/16
1/2	SS-QTM8-S-8AN	SS-QTM8-D-8AN	QTM8	4.2	2.7	2.78 (70.6)	1 5/16

^① To order alloy 400 with PTFE seals, replace **SS** in the ordering number with **M**.

Example: **M**-QTM2-S-4PM

^② For C_v, contact your authorized Swagelok representative.

^③ Include a female 60° cone profile. They accept a 60° male cone with female swivel nut.

Ordering Information and Dimensions, QTM Series

Dimensions are for reference only and are subject to change.

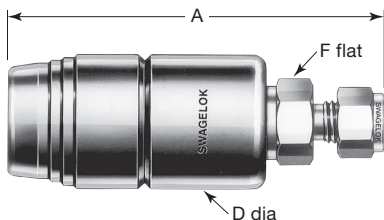

Bodies

Swagelok Tube Fitting



Fitting Size	Ordering Number	Series	Dimensions		
			A	D	F
Dimensions, in. (mm)					
1/4	SS-QTM2A-B-400 ^①	QTM2	3.16 (80.3)	1.12 (28.4)	9/16
	SS-QTM4A-B-400	QTM4	4.08 (104)	1.68 (42.7)	7/8
3/8	SS-QTM2A-B-600	QTM2	3.25 (82.6)	1.12 (28.4)	3/4
	SS-QTM4A-B-600	QTM4	4.08 (104)	1.68 (42.7)	7/8
1/2	SS-QTM8A-B-810	QTM8	4.30 (109)	2.00 (50.8)	1 1/8
3/4	SS-QTM8A-B-1210	QTM8	4.30 (109)	2.00 (50.8)	1 1/8
1	SS-QTM8A-B-1610	QTM8	4.58 (116)	2.00 (50.8)	1 3/8
Dimensions, mm (in.)					
6	SS-QTM2A-B-6M0 ^①	QTM2	80.3 (3.16)	28.4 (1.12)	15
	SS-QTM4A-B-6M0	QTM4	104 (4.08)	42.7 (1.68)	24
8	SS-QTM2A-B-8M0	QTM2	80.3 (3.16)	28.4 (1.12)	15
10	SS-QTM4A-B-10M0	QTM4	104 (4.09)	42.7 (1.68)	24
12	SS-QTM8A-B-12M0	QTM8	109 (4.31)	50.8 (2.00)	30

Dimensions shown with Swagelok tube fitting nuts finger-tight.

^① To order alloy 400 with PTFE seals, replace **SS** in the ordering number with **M**.
Example: **M-QTM2A-B-400**

Insertion Depth

To calculate overall length in the coupled position, subtract the insertion depth from any overall stem and body combination length.

Series	Depth in. (mm)
QTM2	0.89 (22.6)
QTM4	0.95 (24.0)
QTM8	1.15 (29.1)

Male Pipe Threads



Pipe Size in.	Ordering Number	Series	Dimensions, in. (mm)		
			A	D	F
NPT					
1/4	SS-QTM2A-B-4PM ^①	QTM2	3.02 (76.7)	1.12 (28.4)	9/16
	SS-QTM4A-B-4PM	QTM4	3.89 (98.8)	1.68 (42.7)	7/8
3/8	SS-QTM2A-B-6PM	QTM2	3.07 (78.0)	1.12 (28.4)	3/4
	SS-QTM4A-B-6PM	QTM4	3.89 (98.8)	1.68 (42.7)	7/8
1/2	SS-QTM8A-B-8PM	QTM8	4.20 (107)	2.00 (50.8)	1 1/8
3/4	SS-QTM8A-B-12PM	QTM8	4.19 (106)	2.00 (50.8)	1 1/8
1	SS-QTM8A-B-16PM	QTM8	4.48 (114)	2.00 (50.8)	1 3/8
ISO/BSP Tapered					
1/4	SS-QTM2A-B-4MT	QTM2	3.02 (76.7)	1.12 (28.4)	9/16
	SS-QTM4A-B-4MT	QTM4	3.89 (98.8)	1.68 (42.7)	7/8
1/2	SS-QTM8A-B-8MT	QTM8	4.20 (107)	2.00 (50.8)	1 1/8
ISO/BSP Parallel					
1/4	SS-QTM2A-B-4MS	QTM2	2.96 (75.2)	1.12 (28.4)	3/4
	SS-QTM4A-B-4MS	QTM4	3.89 (98.8)	1.68 (42.7)	7/8
1/2	SS-QTM8A-B-8MS	QTM8	4.20 (107)	2.00 (50.8)	1 1/8
JIC 37° Flare^②					
1/4	SS-QTM4A-B-4AN	QTM4	3.89 (98.8)	1.68 (42.7)	7/8
1/2	SS-QTM8A-B-8AN	QTM8	4.20 (107)	2.00 (50.8)	1 1/8

^① To order alloy 400 with PTFE seals, replace **SS** in the ordering number with **M**.
Example: **M-QTM2A-B-4PM**

^② Include a female 60° cone profile. They accept a 60° male cone with female swivel nut.

Ordering Information and Dimensions, QTM Series

Dimensions are for reference only and are subject to change.

Stems

Female Pipe Threads



Pipe Size	Ordering Numbers		Series	Flow Coefficient (C _v)		Dimensions in. (mm)	
	SESO	DESO		SESO	DESO	A	F
NPT							
1/8	SS-QTM2-S-2PF	SS-QTM2-D-2PF	QTM2	0.7	0.7	1.73 (43.9)	5/8
1/4	SS-QTM2-S-4PF ^①	SS-QTM2-D-4PF ^①	QTM2	0.2	0.2	2.04 (51.8)	3/4
	SS-QTM4-S-4PF	SS-QTM4-D-4PF	QTM4	1.4	1.4	2.36 (59.9)	15/16
3/8	SS-QTM2-S-6PF	SS-QTM2-D-6PF	QTM2	0.7	0.6	2.14 (54.4)	7/8
	SS-QTM4-S-6PF	SS-QTM4-D-6PF	QTM4	1.8	1.7	2.48 (63.0)	15/16
1/2	SS-QTM8-S-8PF	SS-QTM8-D-8PF	QTM8	5.1	4.4	2.66 (67.6)	1 5/16
3/4	SS-QTM8-S-12PF	SS-QTM8-D-12PF	QTM8	8.5	7.8	2.66 (67.6)	1 5/16
1	SS-QTM8-S-16PF	SS-QTM8-D-16PF	QTM8	②	②	3.17 (80.5)	1 5/8
ISO/BSP Tapered							
1/4	SS-QTM2-S-4FT	SS-QTM2-D-4FT	QTM2	0.2	0.2	2.04 (51.8)	3/4
	SS-QTM4-S-4FT	SS-QTM4-D-4FT	QTM4	1.4	1.4	2.36 (59.9)	5/16
1/2	SS-QTM8-S-8FT	SS-QTM8-D-8FT	QTM8	5.1	4.4	2.66 (67.6)	1 5/16
ISO/BSP Parallel							
1/8	SS-QTM2-S-2FS	SS-QTM2-D-2FS	QTM2	0.5	0.4	1.73 (43.9)	5/8
1/4	SS-QTM2-S-4FS	SS-QTM2-D-4FS	QTM2	0.6	0.6	2.04 (51.8)	3/4
	SS-QTM4-S-4FS	SS-QTM4-D-4FS	QTM4	1.2	1.2	2.62 (66.5)	5/16
1/2	SS-QTM8-S-8FS	SS-QTM8-D-8FS	QTM8	4.8	3.9	2.66 (67.6)	1 5/16

① To order alloy 400 with PTFE seals, replace **SS** in the ordering number with **M**.
Example: **M**-QTM2A-B-4PF

② For C_v, contact your authorized Swagelok representative.

Bodies

Female Pipe Threads



Pipe Size	Ordering Number	Series	Dimensions, in. (mm)		
			A	D	F
NPT					
1/8	SS-QTM2A-B-2PF	QTM2	2.60 (66.0)	1.12 (28.4)	9/16
1/4	SS-QTM2A-B-4PF ^①	QTM2	2.99 (75.9)	1.12 (28.4)	3/4
	SS-QTM4A-B-4PF	QTM4	3.35 (85.1)	1.68 (42.7)	7/8
3/8	SS-QTM2A-B-6PF	QTM2	3.04 (77.2)	1.12 (28.4)	7/8
	SS-QTM4A-B-6PF	QTM4	3.35 (85.1)	1.68 (42.7)	7/8
1/2	SS-QTM8A-B-8PF	QTM8	3.53 (89.7)	2.00 (50.8)	1 1/8
3/4	SS-QTM8A-B-12PF	QTM8	4.02 (102)	2.00 (50.8)	1 5/16
1	SS-QTM8A-B-16PF	QTM8	4.40 (112)	2.00 (50.8)	1 5/8
ISO/BSP Tapered					
1/4	SS-QTM2A-B-4FT	QTM2	2.99 (75.9)	1.12 (28.4)	3/4
	SS-QTM4A-B-4FT	QTM4	3.35 (85.1)	1.68 (42.7)	7/8
1/2	SS-QTM8A-B-8FT	QTM8	3.92 (99.6)	2.00 (50.8)	1 1/8
ISO/BSP Parallel					
1/8	SS-QTM2A-B-2FS	QTM2	2.60 (66.0)	1.12 (28.4)	9/16
1/4	SS-QTM2A-B-4FS	QTM2	2.99 (75.9)	1.12 (28.4)	3/4
	SS-QTM4A-B-4FS	QTM4	3.35 (85.1)	1.68 (42.7)	7/8
1/2	SS-QTM8A-B-8FS	QTM8	3.53 (89.7)	2.00 (50.8)	1 1/8

① To order alloy 400 with PTFE seals, replace **SS** in the ordering number with **M**.
Example: **M**-QTM2-S-4PF

Ordering Information and Dimensions, QTM Series

Dimensions are for reference only and are subject to change.

Bulkhead Stems

Swagelok Tube Fitting

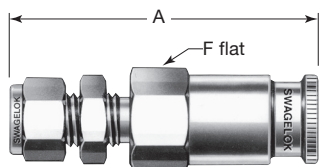

Fitting Size	Ordering Numbers		Series	Flow Coefficient (C _v)		Dimensions			
	SESO	DESO		SESO	DESO	A	F	Max Panel Thickness	Min Panel Hole Dia
Dimensions, in. (mm)									
1/4	SS-QTM4-S1-400	SS-QTM4-D1-400	QTM4	0.9	0.8	3.05 (77.5)	15/16	0.15 (3.8)	29/64 (11.5)
3/8	SS-QTM4-S1-600	SS-QTM4-D1-600	QTM4	1.7	1.6	3.05 (77.5)	15/16	0.15 (3.8)	37/64 (14.7)
1/2	SS-QTM8-S1-810	SS-QTM8-D1-810	QTM8	4.2	3.1	3.54 (89.9)	1 5/16	0.19 (4.8)	49/64 (19.4)
Dimensions, mm (in.)									
6	SS-QTM4-S1-6M0	SS-QTM4-D1-6M0	QTM4	0.9	0.8	77.5 (3.05)	24	3.8 (0.15)	11.5 (29/64)
10	SS-QTM4-S1-10M0	SS-QTM4-D1-10M0	QTM4	1.7	1.6	77.7 (3.06)	24	3.8 (0.15)	16.7 (21/32)
12	SS-QTM8-S1-12M0	SS-QTM8-D1-12M0	QTM8	4.2	3.1	89.9 (3.54)	35	4.8 (0.19)	19.4 (49/64)

Dimensions shown with Swagelok tube fitting nuts finger-tight.

Bulkhead Bodies

Swagelok Tube Fitting

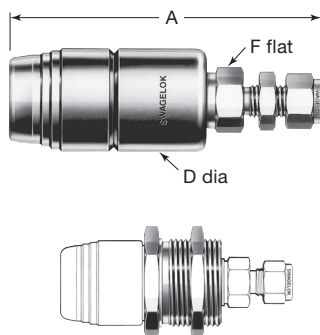

QTM2 Integral Bulkhead

Fitting Size	Ordering Number	Series	Dimensions				
			A	D	F	Max Panel Thickness	Min Panel Hole Dia
Dimensions, in. (mm)							
1/4	SS-QTM2A-B1-400 ^{①②}	QTM2	3.16 (80.3)	1.12 (28.4)	9/16	0.65 (16.5)	1 13/64 (30.6)
	SS-QTM4A-B1-400	QTM4	4.42 (112)	1.68 (42.7)	7/8	0.15 (3.8)	29/64 (11.5)
3/8	SS-QTM4A-B1-600	QTM4	4.51 (115)	1.68 (42.7)	7/8	0.15 (3.8)	37/64 (14.7)
	SS-QTM8A-B1-810	QTM8	4.78 (121)	2.00 (50.8)	1 1/8	0.19 (4.8)	49/64 (19.4)
Dimensions, mm (in.)							
6	SS-QTM2A-B1-6M0 ^{①②}	QTM2	80.3 (3.16)	28.4 (1.12)	15	16.5 (0.65)	30.6 (1 13/64)
	SS-QTM4A-B1-6M0	QTM4	112 (4.42)	42.7 (1.68)	24	3.8 (0.15)	11.5 (29/64)
10	SS-QTM4A-B1-10M0	QTM4	115 (4.52)	42.7 (1.68)	24	3.8 (0.15)	16.7 (21/32)
12	SS-QTM8A-B1-12M0	QTM8	121 (4.77)	50.8 (2.00)	30	4.8 (0.19)	19.4 (49/64)

Dimensions shown with Swagelok tube fitting nuts finger-tight.

① To order alloy 400 with PTFE seals, replace **SS** in the ordering number with **M**.

Example: **M**-QTM2A-B1-400

② QTM2 bodies have an integral bulkhead, as shown at left.

Male NPT

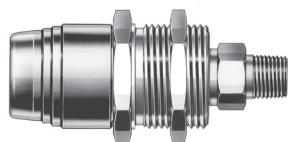

Pipe Size	Ordering Number	Series	Dimensions, in. (mm)				
			A	D	F	Max Panel Thickness	Min Panel Hole Dia
1/4	SS-QTM2A-B1-4PM ^①	QTM2	3.02 (76.7)	1.12 (28.4)	9/16	0.65 (16.5)	1 13/64 (30.6)

① To order alloy 400 with PTFE seals, replace **SS** in the ordering number with **M**.

Example: **M**-QTM2A-B1-4PM

Female NPT

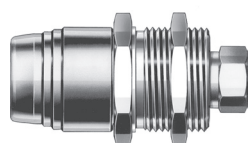

Pipe Size	Ordering Number	Series	Dimensions, in. (mm)				
			A	D	F	Max Panel Thickness	Min Panel Hole Dia
1/8	SS-QTM2A-B1-2PF	QTM2	2.60 (66.0)	1.12 (28.4)	9/16	0.65 (16.5)	1 13/64 (30.6)
1/4	SS-QTM2A-B1-4PF ^①	QTM2	2.96 (75.2)	1.12 (28.4)	3/4	0.65 (16.5)	1 13/64 (30.6)

① To order alloy 400 with PTFE seals, replace **SS** in the ordering number with **M**.

Example: **M**-QTM2A-B1-4PF

Options, QTM Series

Keyed QTM Series

Swagelok keyed quick-connects provide a positive mechanical lockout system to prevent accidental intermixing of different lines in multifluid or multipressure systems.

Features

- Keyed quick-connects will not interchange with any other Swagelok keyed quick-connects
- If an attempt is made to couple unlike keys, the valve system will not open.
- Stems and bodies are color coded and numbered for easy identification.



Body and Stem Protectors

Body and stem protectors are available. Contact your authorized Swagelok representative.

Bodies with Release Button

QTM series bodies are available with an optional release button to prevent accidental uncoupling.

For more information, contact your authorized Swagelok representative.

QTM Series Key Numbers

QTM2 and QTM4 series quick-connects are available in keys K1 through K8.

QTM8 series quick-connects are available in keys K1 through K4 only (black, orange, green, or yellow).

Keyed QTM series sleeve dimensions are the same as the standard QTM sleeve dimensions given in the **Ordering Information and Dimensions** tables.

Key Color	Key Number and Designator
Black	K1
Orange	K2
Green	K3
Yellow	K4
Blue	K5
White	K6
Purple	K7
Brown	K8

Ordering Information

To order, add a key number designator to a QTM series quick-connect ordering number.

Example: SS-QTM2-S-400**K1**

Safe Product Selection

When selecting a product, the total system design must be considered to ensure safe, trouble-free performance. Function, material compatibility, adequate ratings, proper installation, operation, and maintenance are the responsibilities of the system designer and user.

WARNING

Do not mix/interchange Swagelok products or components not governed by industrial design standards, including Swagelok tube fitting end connections, with those of other manufacturers.

Warranty Information

Swagelok products are backed by The Swagelok Limited Lifetime Warranty. For a copy, visit swagelok.com or contact your authorized Swagelok representative.